

Installation Guide, Parts List and Maintenance Instructions

Parts List:

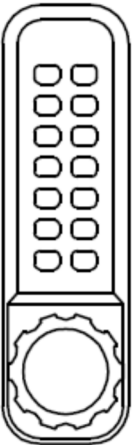

Keypad

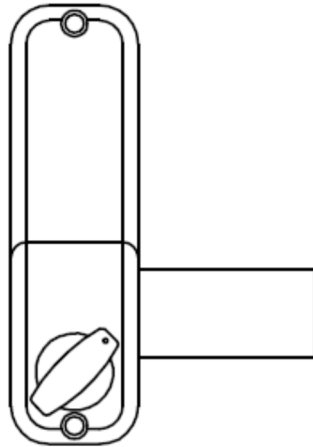

Inside Lock Body

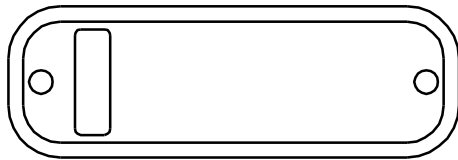

Neoprene Seals x 2

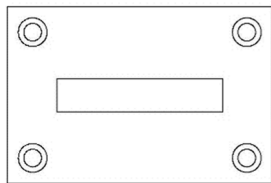

Mortised Lock Keep

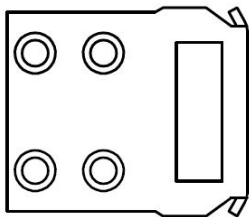

Surface Lock Keep x 2

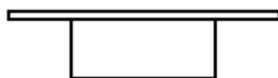

Mortised Lock Keep

Factory Pre-Set Code Card



Wood Screws x 8



Wood Screws x 4



Code Deactivation Plug

Fixing Bolts (6 supplied)

Use only 2 depending on gate thickness. See table 4A.



80 mm x 2 (3-1/8")



70 mm x 1 (2-3/4")



60 mm x 1 (2-3/8")



50 mm x 1 (2")



40 mm x 1 (1-1/2")

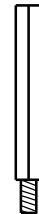

Hexagonal Shaft x 2
2-3/8" (60mm)

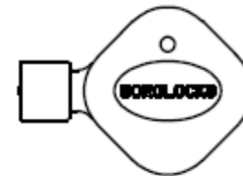

Code Change Key
for Recoding

Spindle / Key Stock x 3



135 mm x 1 (5-5/16")



160 mm x 1 (6-5/16")



135mm x 1 (5-5/16")

Before Commencing Installation

Please check that all parts are working correctly. Per the Factory Pre-Set Code Card provided, press the code into the lock and then turn the knob. It should turn easily under spring pressure. If you intend to change the code, you can do it before or after installation, please refer to the **How to Change your Code** instructions provided below.

How to Change Your Code

The BL2605-ECP MGPro model is equipped with the **EasicodePro (ECP)** code changing system which allows quick and convenient code changes while the lock is installed on the gate or door. Please read the directions provided below and/or visit www.snugcottagehardware.com and look under Borg Locks for a "How To" video which effectively shows the process.



In order to change the code, you must know the existing code and all changes should be done with the gate or door in the open position. Please refer to the code card provided with the lock for the factory pre-set code. We encourage you to take your time to ensure you enter the new code correctly and to write down any changes you make for reference later.



QR Code directs you to a How to Change your Code Video.

STEP 1: Open the gate or door and enter the existing code into the keypad without turning the knob.

STEP 2: Insert the Code Change Key into the hole on the "*" button. Fully push-in and hold-in until you reach Step 5.

STEP 3: Press the "C" button to clear the existing code.

STEP 4: Enter the new code.

STEP 5: Release the Code Change Key from the hole in the "*" button.

STEP 6: Press the "C" button to set the new code.

STEP 7: The new code is now set and ready for use.

STEP 8: Before closing the gate or door, check that the new code is working five (5) times and that the latch dead bolt is withdrawing correctly each time.

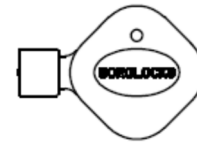

Code Change Key for Recoding

Please note, if a mistake is made while entering a new code (with the "*" button pressed), the "C" button can be pressed to cancel all buttons that have been previously pressed so that you can start again.

Additionally, you can either increase the number of digits in your code to 6-7 or reduce your code to 3-4 digits. Numbers and letters cannot be repeated within a code; they may only be part of the code once (i.e. the code "1234" would be acceptable to use, while "1224" would not).

Deactivating the On The Door Code Change Function

If you know you will never need to change the code or you don't want someone else to change the code without your knowledge, it is possible to disable the On The Door Code Change Function.

An On The Door Code Change Deactivation Plug is supplied with each lock. Insert the plug into the hole located on the back of the push button keypad with the red indicating arrow (just below X). Please refer to the diagram below. Ensure that the domed part of the deactivation plug is facing out toward you when inserted.

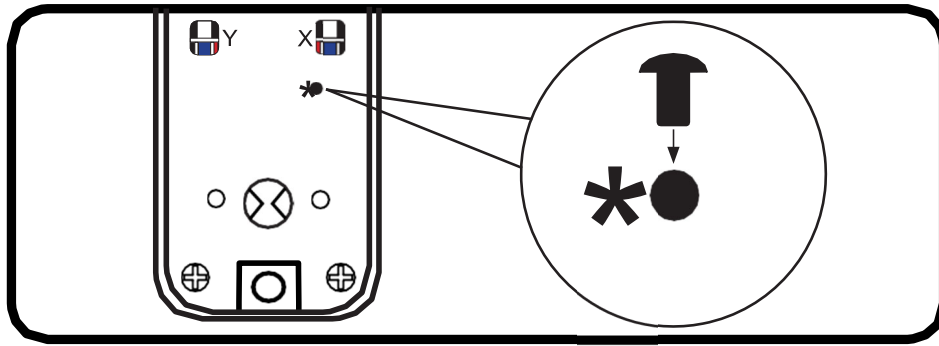

Please note, if the On The Door Code Change Deactivation Plug is inserted/fitted to the back of the push button keypad, the code will not be able to be changed as described previously in these instructions. If at a later date the On The Door Code Change Function is required, the keypad will need to be removed from the lock body and the deactivation plug taken out.

Gate Thickness Table: Table 2A

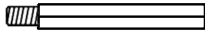
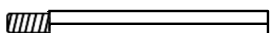
Borg Lock Table			
Hexagonal Shaft Length	Length of Screws Installed	Minimum Gate Thickness	Maximum Gate Thickness
 <p>Short 1" (24mm) length supplied on lock</p>	1-1/2" & 2"	1-1/4"	1-7/8"
	2" & 2-3/8"	1-1/2"	2-3/8"
	2-3/8" & 2-3/4"	2"	2-5/8"
	2-3/4" & 3-1/8"	2-3/8"	3"
	3-1/8" & 3-1/8"	2-5/8"	3-1/8"
 <p>Long 2 3/8" (60mm) length supplied additionally</p>	1-1/2" & 2"	2-1/2"	3-1/4"
	2" & 2-3/8"	3"	3-1/2"
	2-3/8" & 2-3/4"	3-3/8"	4-1/4"
	2-3/4" & 3"	3-3/4"	4-1/4"
	3-1/8" & 3-1/8"	4-1/4"	4-1/4"
Note: Cut Keystock/Spindle 1-7/8" longer than the thickness of your gate or door.			

Determining Your Gate Handing (Table 3A)

Right Hand installation shown below.

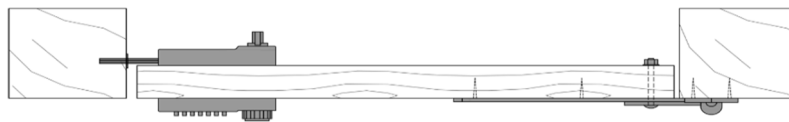

FLUSH ON THE OUTSIDE

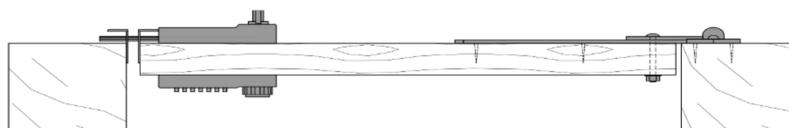

FLUSH ON THE INSIDE

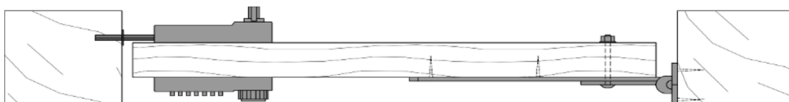

INSTALLED IN CENTER OF OPENING

Changing the Handing of Lock (Table 4A)

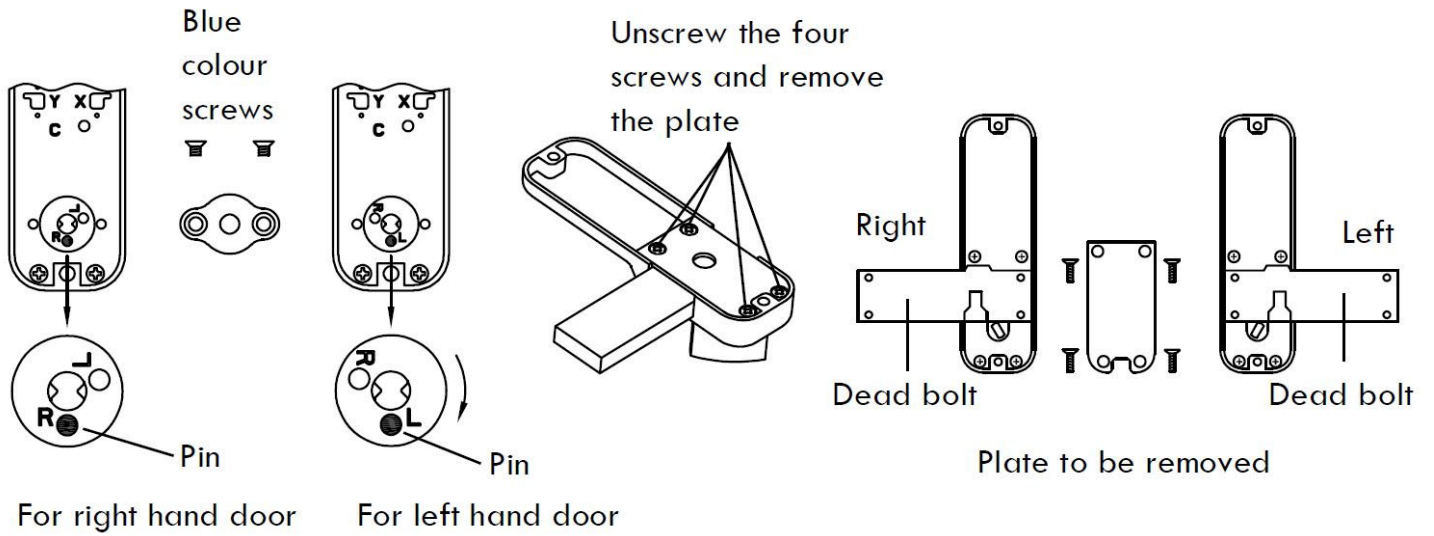

Installation Exploded View (Table 5A)

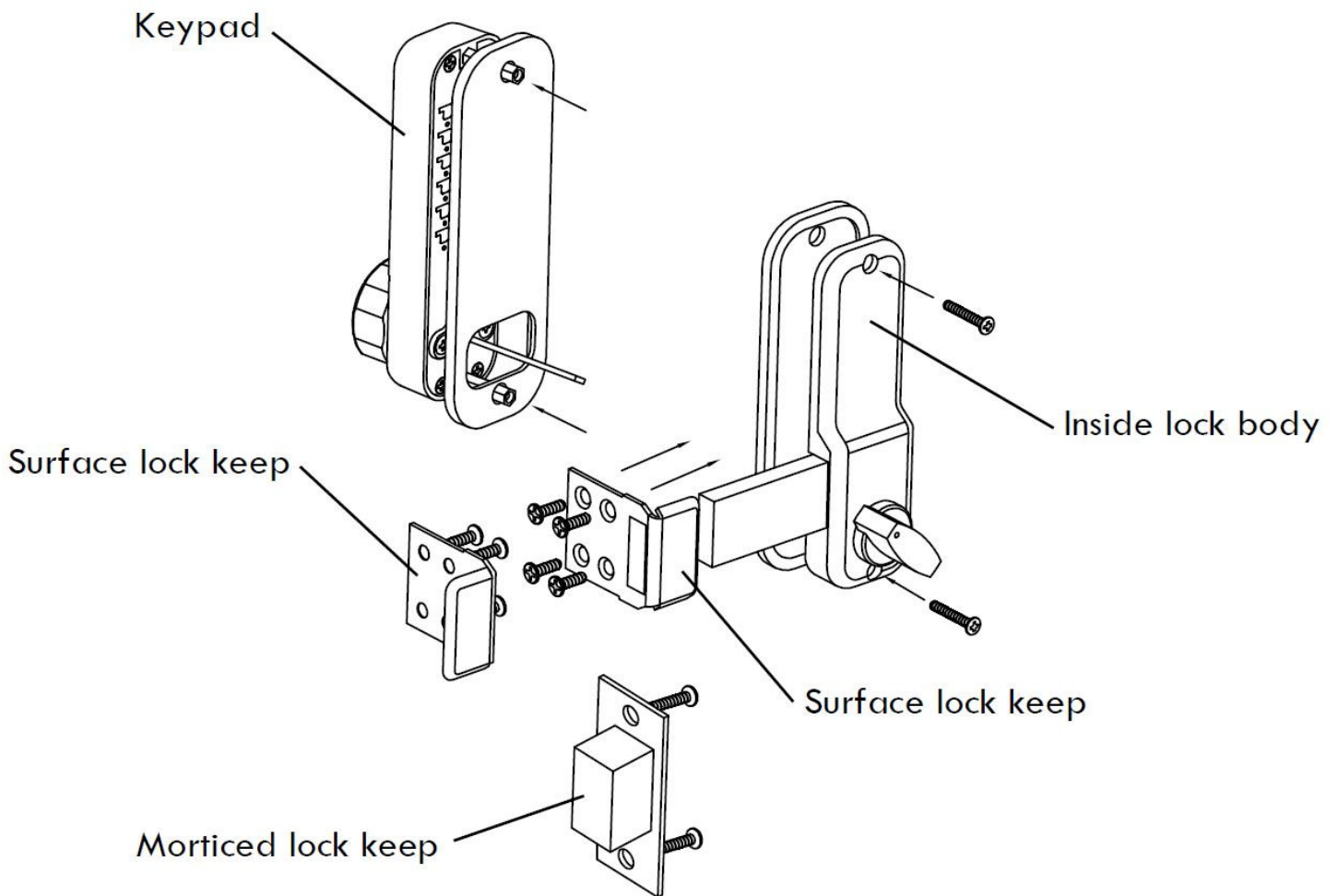

Installation Instructions:

1. Using Diagram 3 determine which hand (left or right) lock you require for your specific application.
2. Using table 2A determine the length of the machine screws, hexagonal shaft and key stock spindle configuration required for your gate or door thickness. This lock comes equipped to fit up to a 4 1/4" thick gate or door.
3. Using a hack saw cut the key stock spindle 1 7/8" longer than the thickness of your gate or door. Be careful the key stock spindle is not cut too long as pinching it in between the two parts of the lock body when you install the machine screws during assembly will possibly prevent free movement of the lock parts.
 - a. for gates or doors under the 1-3/4" thickness use the flat key stock spindle and cut to the appropriate length for your application.
 - b. for gates or doors between 1-3/4" and 3" thick use the key stock spindle that is 135mm and has the heavier "round" part in the middle – the heavier stock will resist twisting better at the longer lengths.
 - c. For gates or doors between 2-3/4" and 4-1/4" thick use the key stock spindle that is 160mm and has the heavier "round" part in the middle – the heavier stock will resist twisting better at the longer lengths.

Note: Please take care in cutting the Keystock/Spindles that you cut the correct amount off each end. The Keystock/Spindle seats into the back part of each half of the lock a different depth so you need to account for this when using the Keystock/Spindles that are round in the middle – you will need to cut a little from both ends.

4. Using the supplied drilling template locate where the holes will be drilled in your gate or door by marking the centres. NOTE: The horizontal placement of the lock does not have to match the "edge of door" reference on the drilling template. As the latching bolt moves a full 1" in its action. If using in the mortised position for instance, it may be advantageous to move the lock position backwards or forwards depending on your specific installation. Please pay special attention to this step to ensure best results.
5. Once you have determined the locks most suitable position, mark the 3 hole centers for drilling, using the appropriate sized bits. The template indicates 10mm (3/8") and 13mm (1/2") holes. Place a block on the opposite side of the door or gate too minimize tear out while drilling.
6. If you haven't already changed the code or the handing, but wish to change the code or the handing, please refer to "How to Change Your Code" and "How to Change the Handing (Table 4A)" and do so now.
7. Add the black rubber lock base gaskets to each of the lock pieces at this time.
8. After reviewing the exploded view Table 5A - Carefully affix the lock to the door or gate using the appropriately sized machine screws as determined in step 2. Be sure to install your key stock spindle at this time. **NOTE:** take great care when starting the threads in the hexagonal shaft not to cross thread them. The threads are very fine- it is easy to make a mistake. Tighten gently, do not overtighten.
9. Now the lock position is set you can install surface lock keeps for flush mount applications, or one surface lock keep and one mortise lock keep for mortised installations. Both have elongated receiver slots to allow for some post movement and settling.
10. Test the lock for accurate operation once complete

Maintenance Instructions:

Monthly:

Clean the surface of the lock with a silicon-based lubricant, remove any excess with a soft cloth. Do **NOT** use an oil-based spray like WD40 as this will attract dirt and debris.

Annually:

Remove the lock from the door.

Spray the inside of the lock thoroughly with a silicon-based lubricant, through the tumbler holes at the back of the lock. Spray all the fixing accessories and the latch with a silicon-based lubricant.

Push each of the buttons and rotate the knob several times to ensure that the lock is working smoothly and the lubricant has penetrated the lock appropriately. These procedures can be carried out as needed when lock is sticky or code is accepted intermittently.

If you experience any problems when installing this lock, or changing the code please contact:



SNUG COTTAGE HARDWARE
Marysville Michigan, USA and London, Ontario, Canada
1-800-637-5427
www.snugcottagehardware.com

