

DOUBLE "V" RAIL GATE PLAN

Single Gate Configuration - Tapered Top Rail

(4 FOOT WIDE 48" HIGH GATES) **CENTRAL EYE HINGES** (Product Codes #8312) **GATE HUNG BETWEEN POSTS**

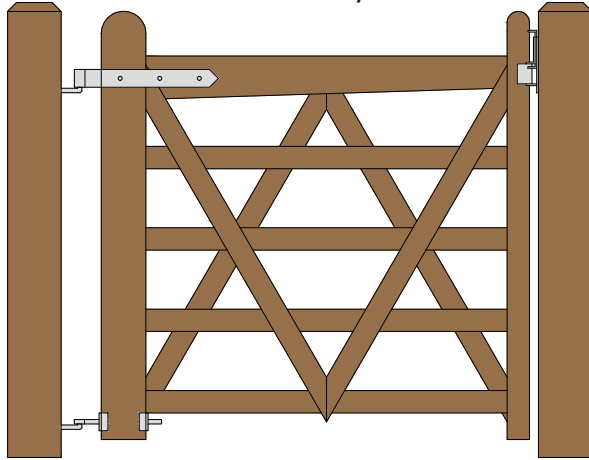

Distance between latch post and gate	A
Width of Gate	B
Distance between gate and hinge post	C
Total distance between posts	D

Hardware Required						
	Galvanized Finish	Black Powder Coat over Galvanized Finish	Central Eye Hinge Advantages			
Hinge Set	8312-S122	8312-S12P	Opens both ways 100 degrees Incredible amount of adjustment Easy operation Very strong			
All fasteners are included with the hardware sets	Set Includes					
	one 12 inch double strap (8312-422 or 8312-42SP) one adjustable bottom gate fitting (8250-002 or 8250-00P) two 12" adjustable gate pin (8800-122 or 8800-12P)					
	Central Latch Options		Dimensions (feet and inches)			
			A	B	C	D
Quick Catch (shown above)	4100-3SS	4100-3BSS	1.5"	4'	4.5"	4'-6"
Spring Latch	8327-002	8327-00P	4"	4'	4.5"	4'-8.5"
Slide Bolt Latch (Flush or Jamb)	5002-L122	5002-L12SP	1"	4'	4.5"	4'-5.5"
Lumber Required						
Posts	2 of 8' x 6" x6" (usually dressed out at 5.5" x 5.5")					
Rails, Stiles(uprights) and Diagonal Braces made from full 1" thick by 5.5" wide lumber (commonly stocked decking material or rough cut lumber) we then cut down what we needed to the 2.5" width dimension for most of the gate and in the process removed any prefinished, rounded corners						
Top Rail(tapered)	3 of 4' x 1" x 5.5"					
Rails	1 of 8' x 1" x 5.5" (cut to 2.5" x 4')					
Stiles	3 of 4' x 1" x 5.5" (2 x 5" for the hinge side and 2 x 2.5" for the latch side)					
Diagonals	1 of 8' x 1" x 5.5" (cut to 2.5" x 4')					
Filler Pieces	use off cuts from other pieces for all filler pieces					
Fasteners Required						
FP-Double V - Fastener Pack for Double V Gate Build (incl. 14 of 3.5" and 15 of 2.5" carriage bolts w nuts and washers & 40 of 1.75" wood screws)						
Optional Hold Back - Use a 12" Cabin Hook (4270-122 or 4270-12SP) if you require a means of keeping the gate open						

SNUG COTTAGE HARDWARE

Download includes this materials list, component cutting and layout sheet, tips on installing gate posts, and detailed instructions.
 For a complete listing of our free gate plans and gate layouts visit snugcottagehardware.com.

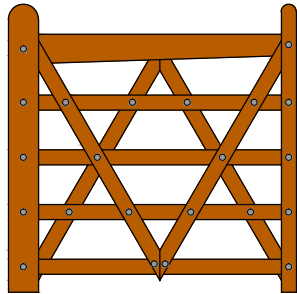

4' DOUBLE 'V' GATE

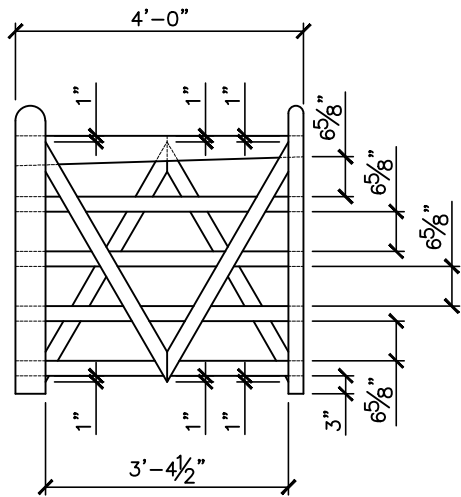

GATE DIMENSIONS

PROPERTY OF:
 SNUG COTTAGE
 HARDWARE LLC
 MARYSVILLE MI.
 48040

PRODUCT DESCRIPTION:
 4' DOUBLE 'V' GATE
 ALL DIMENSIONS ± 0.125 "

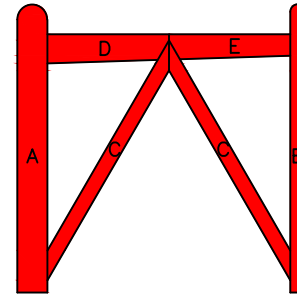

FIRST LAYER

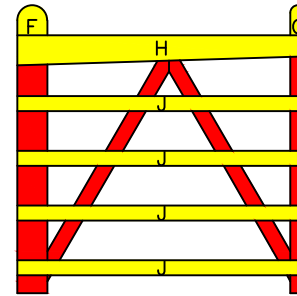

SECOND LAYER

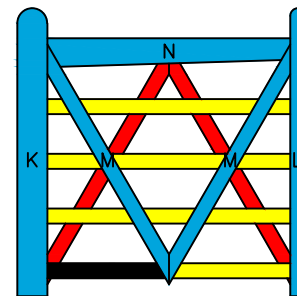

THIRD LAYER

BUILDING STEPS

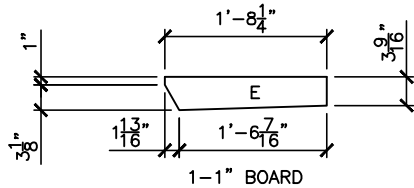
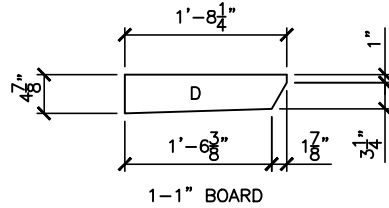
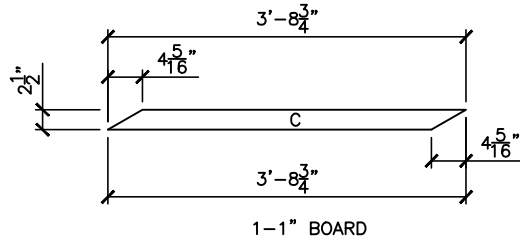
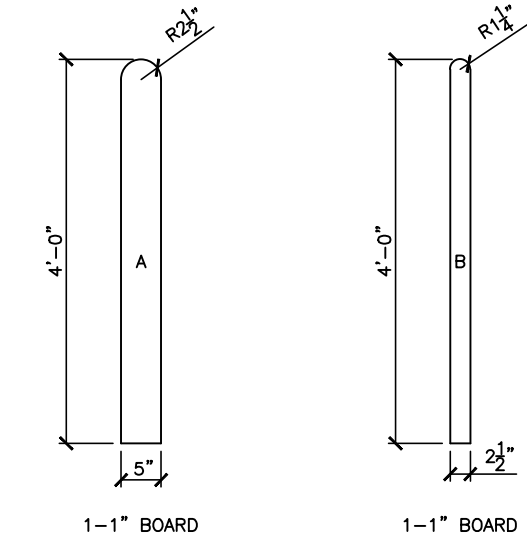

FIRST LAYER COMPONENTS

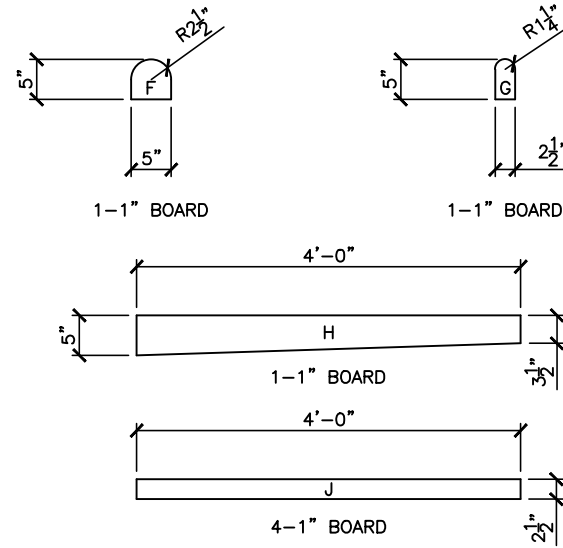

SECOND LAYER COMPONENTS

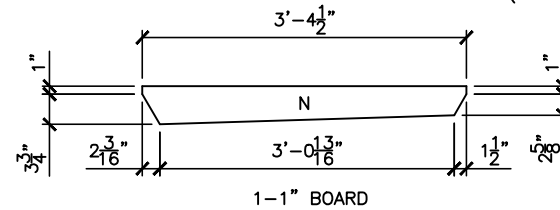
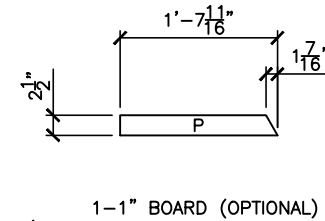
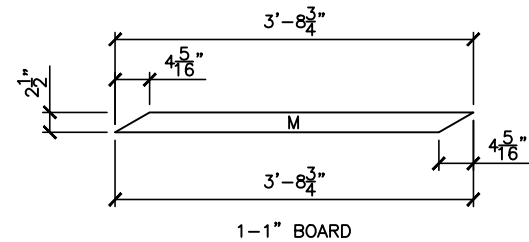
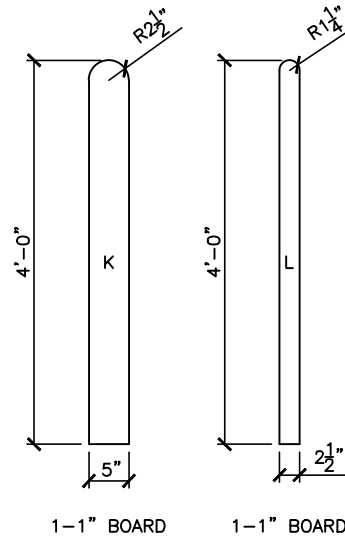

THIRD LAYER COMPONENTS

PROPERTY OF:
SNUG COTTAGE
HARDWARE LLC
MARYSVILLE MI.
48040

PRODUCT DESCRIPTION:
4' DOUBLE 'V' GATE COMPONENTS
ALL DIMENSIONS ±0.125"