

# DOUBLE "V" RAIL GATE PLAN

## Double Gate Configuration - Tapered Top Rail

(4' & 10' WIDE 48" HIGH GATES) **CENTRAL EYE HINGES** (Product Codes #8312) **GATE HUNG BETWEEN POSTS**

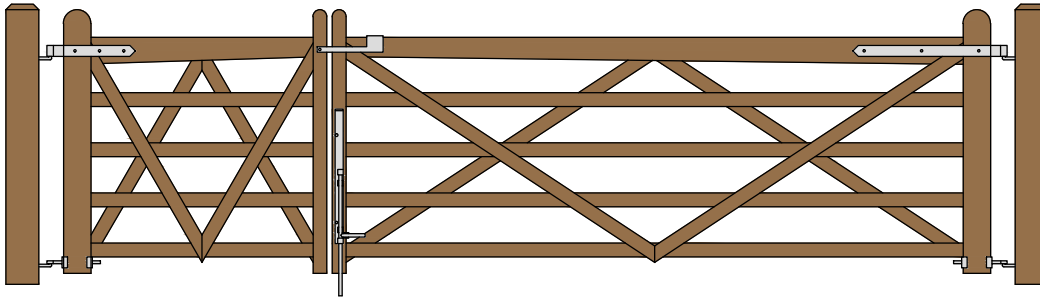

Distance between gate and hinge post	A
Width of Left Gate	B
Distance between gates	C
Width of Right Gate	D
Distance between gate and hinge post	E
Total distance between posts	F

		Hardware Required		Central Eye Hinge Advantages					
		Galvanized Finish	Black Powder Coat over Galvanized Finish						
Hinge Sets		1 of 8312-S122 and 1 of 8312-S242	1 of 8312-S12P and 1 of 8312-S24P	Opens both ways 100 degrees Incredible amount of adjustment Easy operation Very strong					
All fasteners are included with hardware sets	<b>Two Hinge Sets Include</b>								
	one 12 inch double strap (8312-422 or 8312-42SP) & one 18" double strap (8312-542 or 8312-54SP) two adjustable bottom gate fitting (8250-002 or 8250-00P) four 12" adjustable gate pin (8800-122 or 8800-12P)								
Cane Bolt (Vertical)		1 or 2 of 5000-242*	1 or 2 of 5000-24SP*						
All fasteners are included with latches	<b>Central Latch Options</b>			Dimensions (feet and inches)					
				A	B	C	D	E	F
Throw Over Gate Loop(shown)		4200-032	4200-03SP	4.5"	4'	1"	10'	4.5"	14' 10"
Slide Bolt Latch (Flush/ Jamb Mount)		5002-L122	5002-L12SP	4.5"	4'	1"	10'	4.5"	14' 10"
		Lumber Required							
Posts		2 of 8' x 6" x6" (usually dressed out at 5.5" x 5.5")							
		Rails, Stiles(uprights) and Diagonal Braces made from full 1" thick by 5.5" wide lumber (commonly stocked decking material or rough cut lumber) we then cut down what we needed to the 2.5" width dimension for most of the gate and in the process removed any prefinished, rounded corners							
Top Rails (Tapered)		2 of 8' x 1" x 5.5" and 3 of 10' x 1" x 5.5"							
Rails		1 of 8' x 1" x 5.5" and 1 of 10' x 1" x 5.5" (cut to 2.5" wide)							
Stiles		3 of 8' x 1" x 5.5" (4 @ 4' x 5" for hinge side and 4 @ 4' x 2.5" for latch side)							
Diagonals		1 of 8' x 1" x 5.5" and 1 of 12' x 1" x 5.5"							
Filler Pieces		use off cuts from other pieces for all filler pieces							
		Fasteners Required							
		2 of FP-DoubleV- Fastener pack for Double V Gate Build (One pack includes: 14 of 3.5" and 15 of 2.5" carriage bolts with nuts and washers & 40 of 1.75" wood screws)							
		*One 24" Cane Bolt (5000-242 or 5000-24SP) is required for central stability. Two are needed if you require a means of keeping the gates open.							

### SNUG COTTAGE HARDWARE

Download includes this materials list, component cutting and layout sheet, tips on installing gate posts, and detailed instructions.  
 For a complete listing of our free gate plans and gate layouts visit [snugcottagehardware.com](http://snugcottagehardware.com).

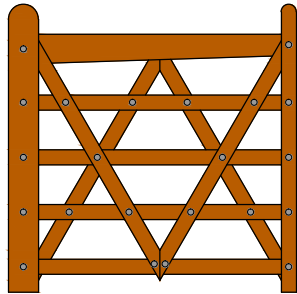

4' DOUBLE 'V' GATE

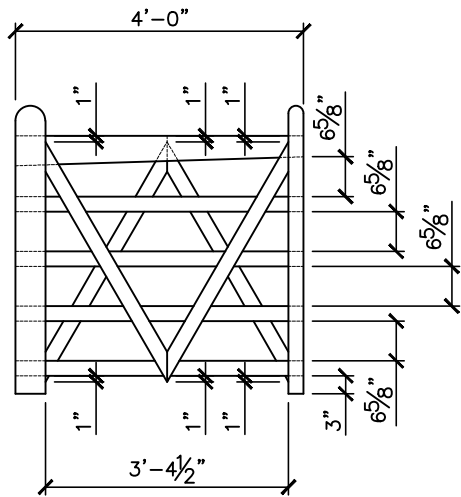

GATE DIMENSIONS

PROPERTY OF:  
 SNUG COTTAGE  
 HARDWARE LLC  
 MARYSVILLE MI.  
 48040

PRODUCT DESCRIPTION:  
 4' DOUBLE 'V' GATE  
 ALL DIMENSIONS  $\pm 0.125$ "

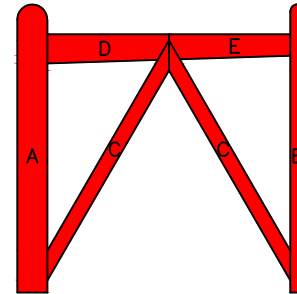

FIRST LAYER

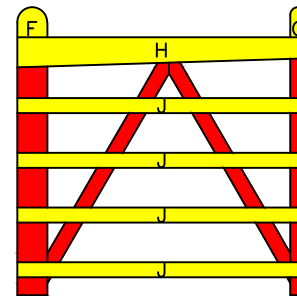

SECOND LAYER

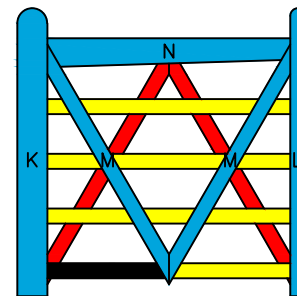

THIRD LAYER

BUILDING STEPS

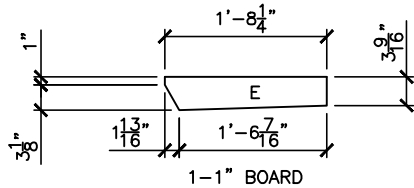
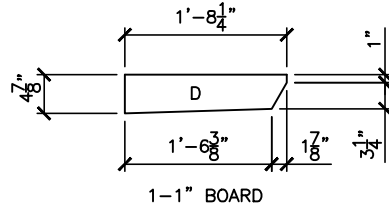
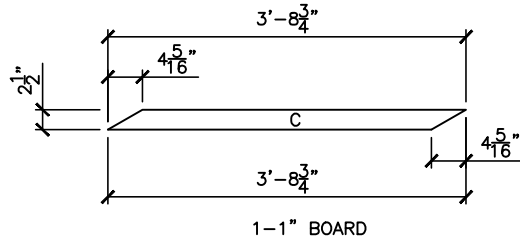
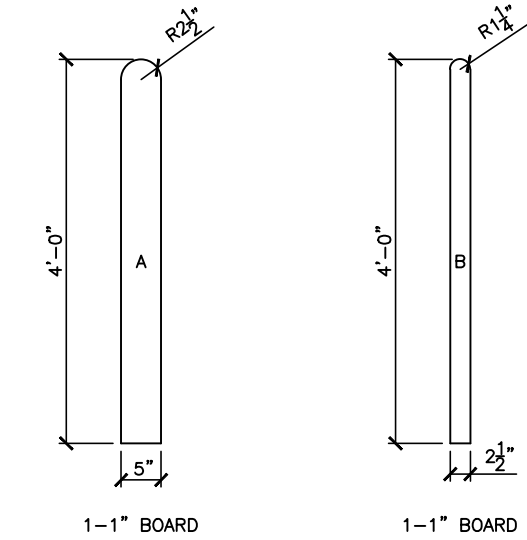

FIRST LAYER COMPONENTS

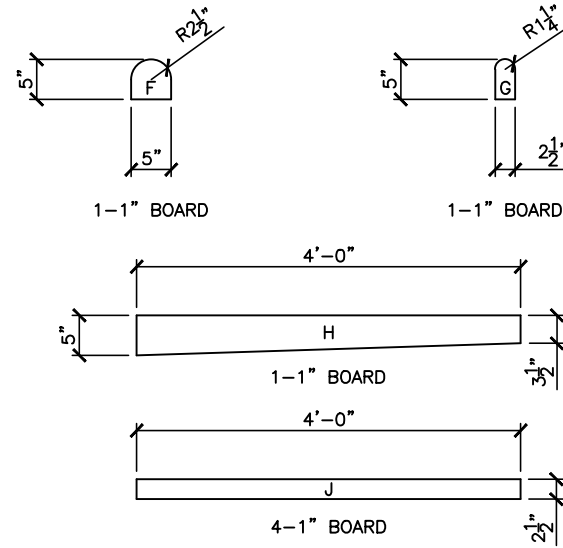

SECOND LAYER COMPONENTS

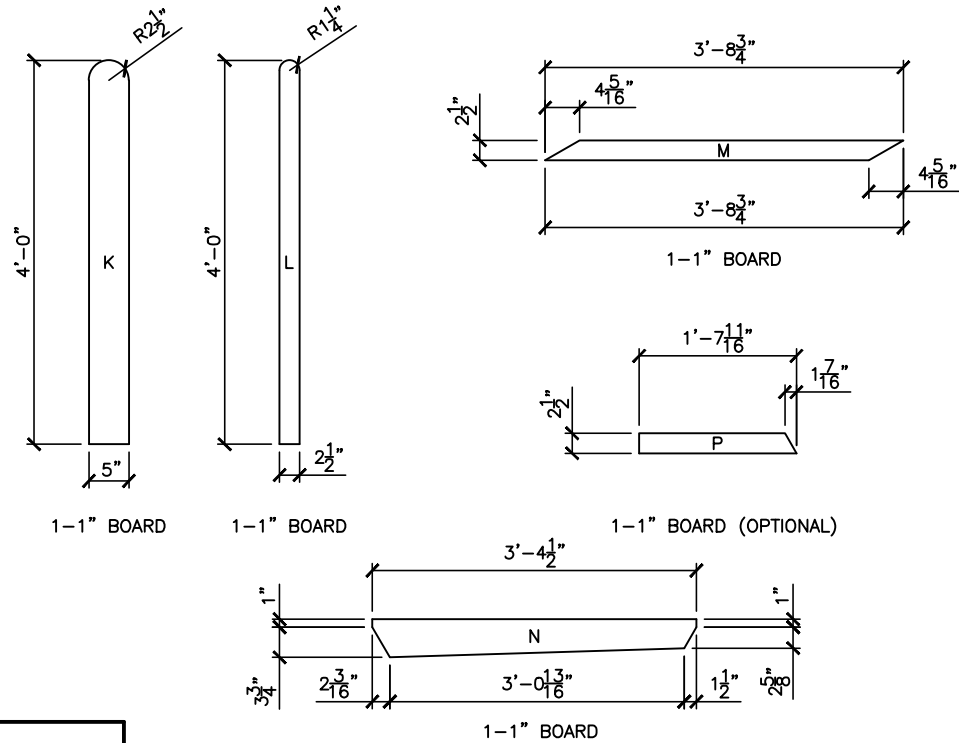

THIRD LAYER COMPONENTS

PROPERTY OF:

SNUG COTTAGE  
HARDWARE LLC  
MARYSVILLE MI.  
48040

PRODUCT DESCRIPTION:

4' DOUBLE 'V' GATE COMPONENTS

ALL DIMENSIONS  $\pm 0.125"$

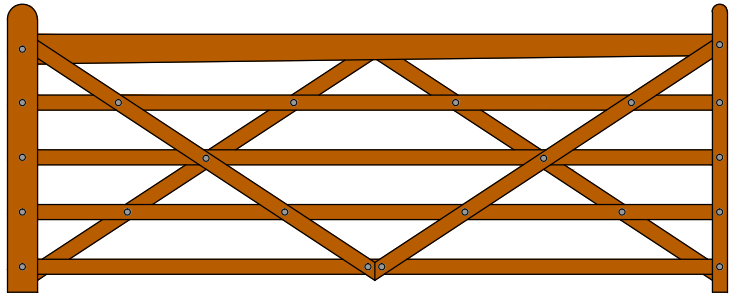

10' DOUBLE 'V' GATE

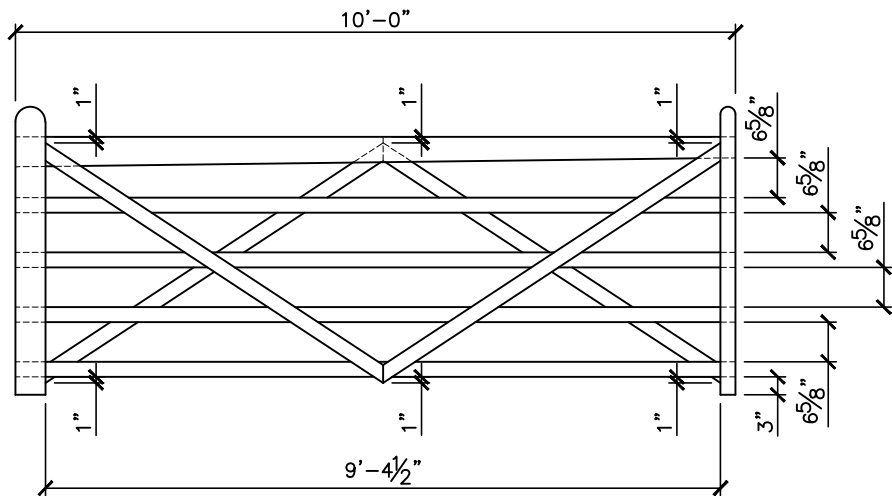

GATE DIMENSIONS

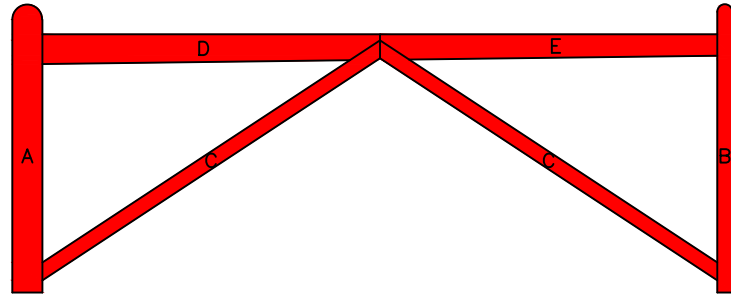

FIRST LAYER

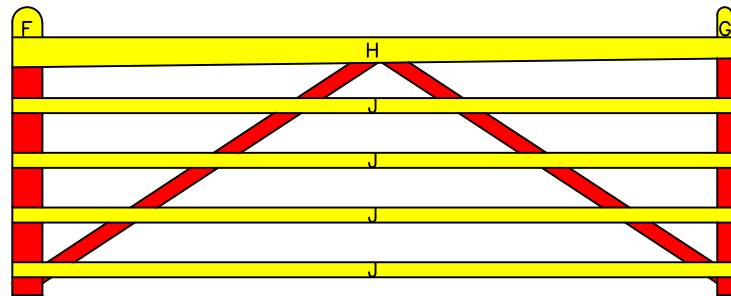

SECOND LAYER

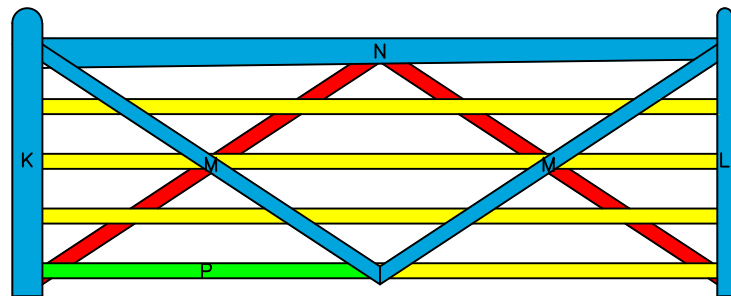

THIRD LAYER

BUILDING STEPS

PROPERTY OF:  
 SNUG COTTAGE  
 HARDWARE LLC  
 MARYSVILLE MI.  
 48040

PRODUCT DESCRIPTION:  
 10' DOUBLE 'V' GATE  
 ALL DIMENSIONS  $\pm 0.125$ "

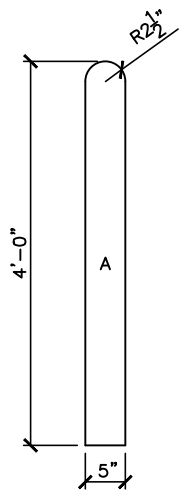

1-1" BOARD

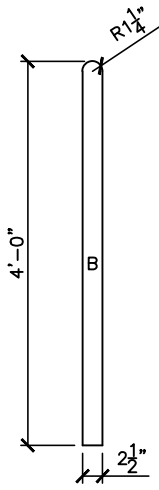

1-1" BOARD

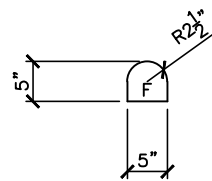

1-1" BOARD

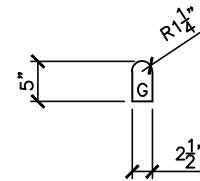

1-1" BOARD

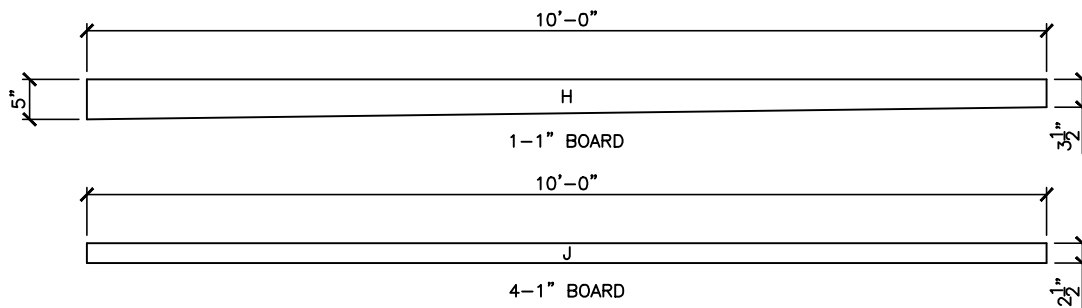

SECOND LAYER COMPONENTS

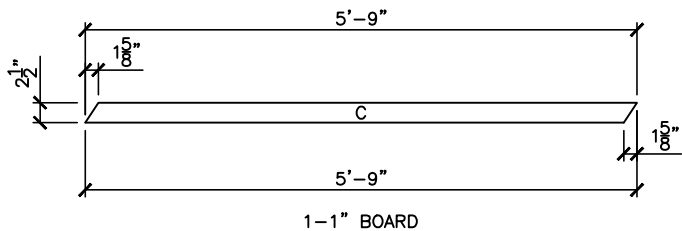

1-1" BOARD

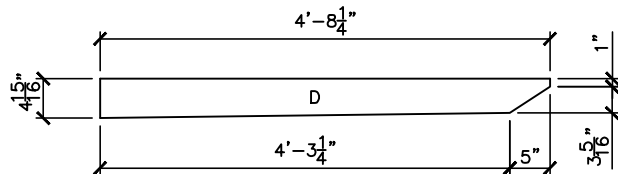

1-1" BOARD

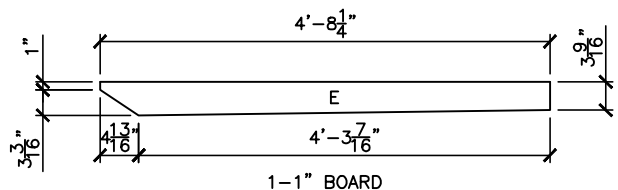

1-1" BOARD

FIRST LAYER COMPONENTS

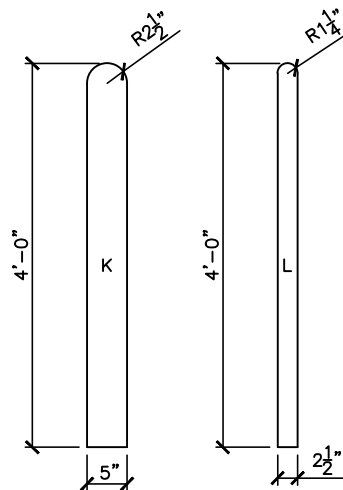

1-1" BOARD

1-1" BOARD

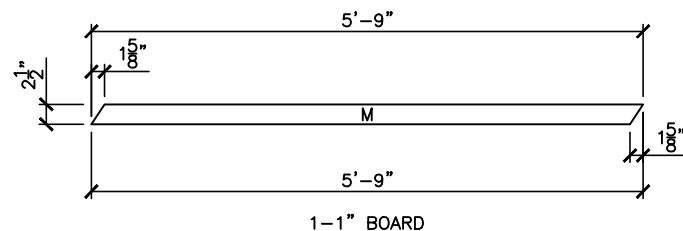

1-1" BOARD

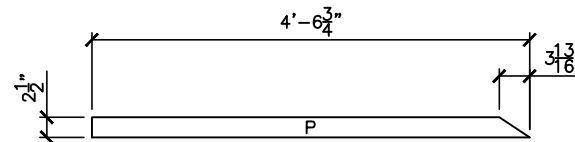

1-1" BOARD (OPTIONAL)

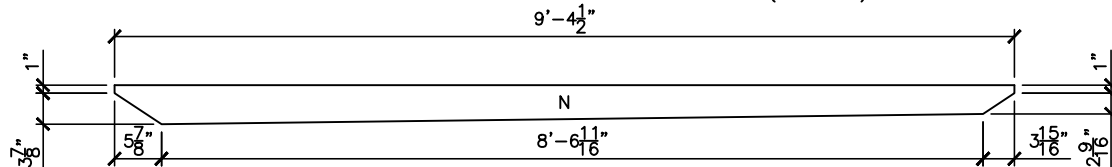

1-1" BOARD

THIRD LAYER COMPONENTS

PROPERTY OF:

SNUG COTTAGE  
HARDWARE LLC  
MARYSVILLE MI.  
48040

PRODUCT DESCRIPTION:

10' DOUBLE 'V' GATE COMPONENTS

ALL DIMENSIONS ±0.125"