

DOUBLE "V" RAIL GATE PLAN

Double Gate Configuration - Tapered Top Rail

(4' & 4' WIDE 48" HIGH GATES) **CENTRAL EYE HINGES** (Product Codes #8312) **GATE HUNG BETWEEN POSTS**

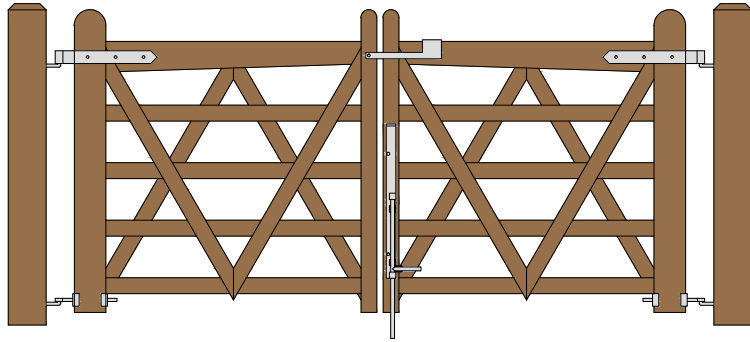

Distance between gate and hinge post	A
Width of Left Gate	B
Distance between gates	C
Width of Right Gate	D
Distance between gate and hinge post	E
Total distance between posts	F

Hardware Required								
	Galvanized Finish	Black Powder Coat over Galvanized Finish	Central Eye Hinge Advantages					
Hinge Sets	2 of 8312-S122	2 of 8312-S12P	Opens both ways 100 degrees Incredible amount of adjustment Easy operation Very strong					
All fasteners are included with hardware sets	Two Hinge Sets Include							
	two 12 inch double strap (8312-422 or 8312-42SP) two adjustable bottom gate fitting (8250-002 or 8250-00P) four 12" adjustable gate pin (8800-122 or 8800-12P)							
Cane Bolt (Vertical)	1 or 2 of 5000-242*	1 or 2 of 5000-24SP*						
All fasteners are included with latches	Central Latch Options					Dimensions (feet and inches)		
			A	B	C	D	E	F
Throw Over Gate Loop (shown)	4200-032	4200-03SP	4.5"	4'	1"	4'	4.5"	8' 10"
Slide Bolt Latch (Flush/ Jamb Mount)	5002-L122	5002-L12SP	4.5"	4'	1"	4'	4.5"	8' 10"
Lumber Required								
Posts	2 of 8' x 6" x6" (usually dressed out at 5.5" x 5.5")							
Rails, Stiles (uprights) and Diagonal Braces made from full 1" thick by 5.5" wide lumber (commonly stocked decking material or rough cut lumber) we then cut down what we needed to the 2.5" width dimension for most of the gate and in the process removed any prefinished, rounded corners								
Top Rail (Tapered)	3 of 8' x 1" x 5.5" (8' boards will be cut in half)							
Rails	2 of 8' x 1" x 5.5" (cut to 2.5" x 4')							
Stiles	3 of 8' x 1" x 5.5" (4 @ 4' x 5" for hinge side and 4 @ 4' x 2.5" for latch side)							
Diagonals	2 of 8' x 1" x 5.5" (cut to 2.5" x 4')							
Filler Pieces	use off cuts from other pieces for all filler pieces							
Fasteners Required								
2 of FP-Double V- Fastener Pack for Double V Gate Build (One pack includes: 14 of 3.5" and 15 of 2.5" Carriage bolts with nuts and washers & 40 of 1.75" Wood Screws)								
*One 24" Cane Bolt (5000-242 or 5000-24SP) is required for central stability. Two are needed if you require a means of keeping the gates open.								

SNUG COTTAGE HARDWARE

Download includes this materials list, component cutting and layout sheet, tips on installing gate posts, and detailed instructions.
 For a complete listing of our free gate plans and gate layouts visit snugcottagehardware.com.

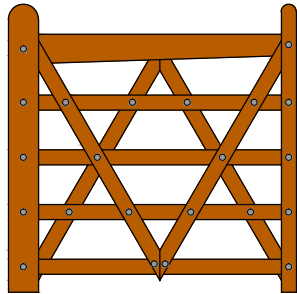

4' DOUBLE 'V' GATE

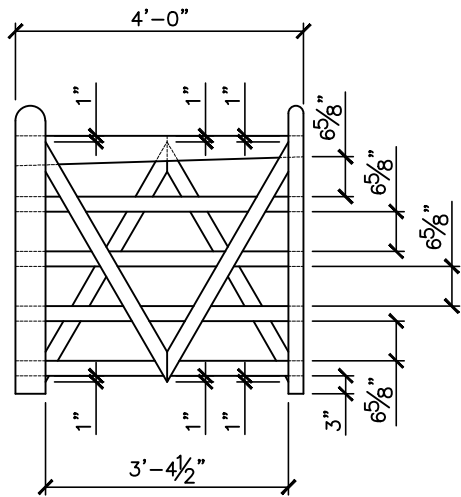

GATE DIMENSIONS

PROPERTY OF:
 SNUG COTTAGE
 HARDWARE LLC
 MARYSVILLE MI.
 48040

PRODUCT DESCRIPTION:
 4' DOUBLE 'V' GATE
 ALL DIMENSIONS ± 0.125 "

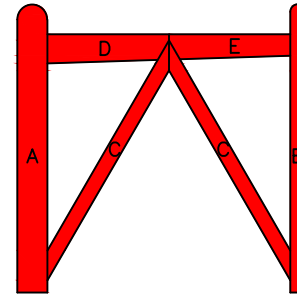

FIRST LAYER

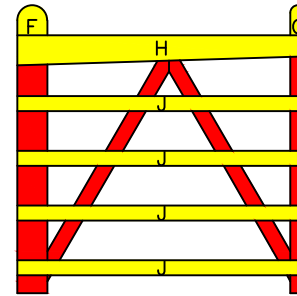

SECOND LAYER

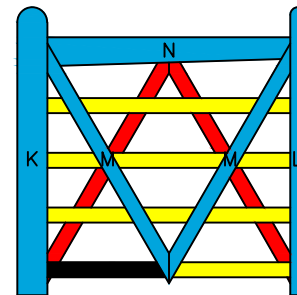

THIRD LAYER

BUILDING STEPS

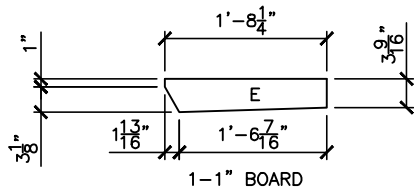
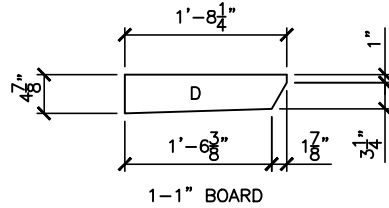
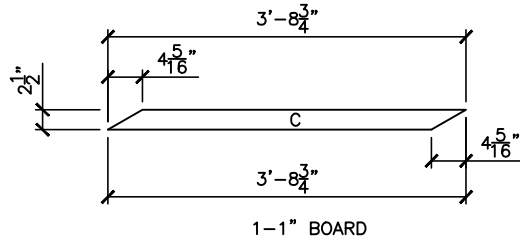
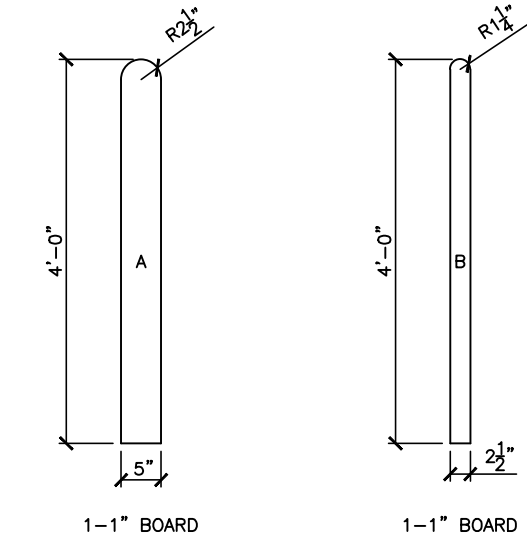

FIRST LAYER COMPONENTS

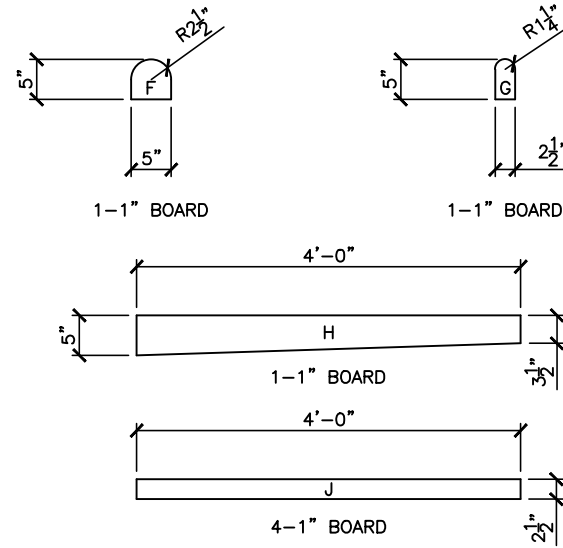

SECOND LAYER COMPONENTS

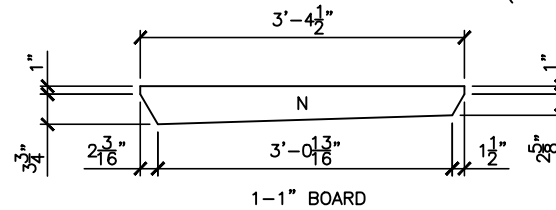
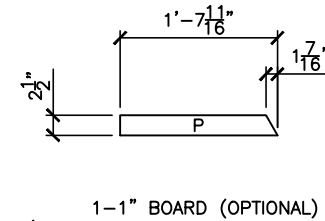
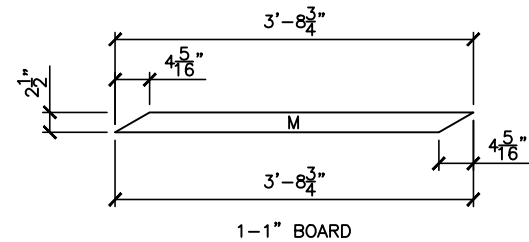
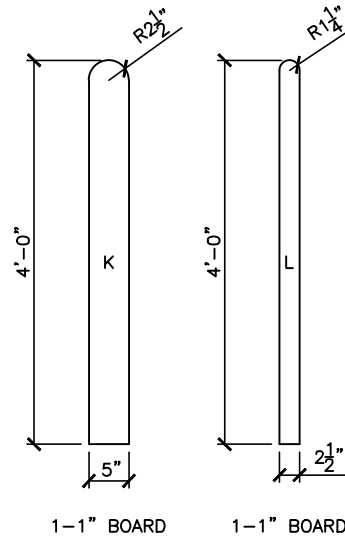

THIRD LAYER COMPONENTS

PROPERTY OF:

SNUG COTTAGE
HARDWARE LLC
MARYSVILLE MI.
48040

PRODUCT DESCRIPTION:

4' DOUBLE 'V' GATE COMPONENTS

ALL DIMENSIONS $\pm 0.125"$