

FRONT

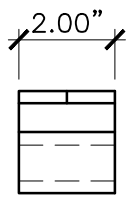

TOP

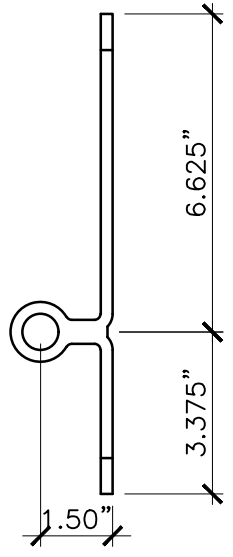

SIDE

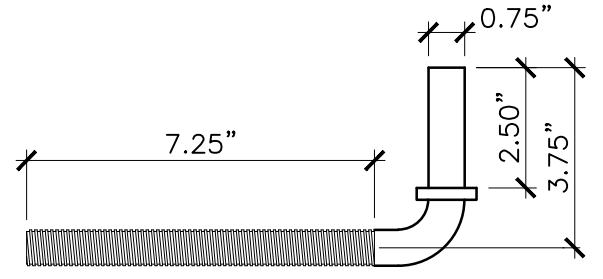

SIDE

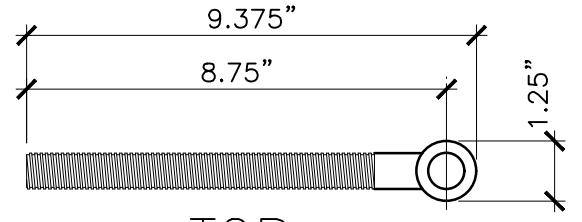

TOP

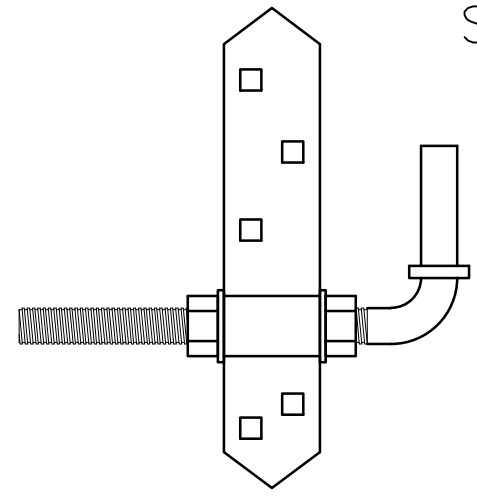

FRONT ASSEMBLED

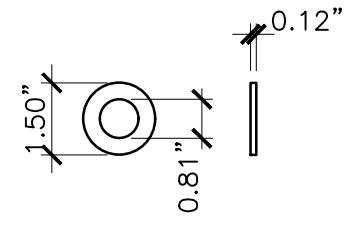

WASHER X2

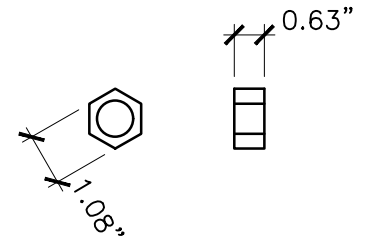

NUT X2

<p>PROPERTY OF:</p> 	<p>PRODUCT DESCRIPTION:</p> <p>ADJUSTABLE HINGE MOUNT WITH 8" THREADED PIN</p> <p>ALL DIMENSIONS <math>\pm 0.125"</math></p>	<p>PART NUMBER:</p> <p>8256</p>
---	--	---------------------------------