

BL2615MG

Installation Guide, Parts List & Maintenance Instructions

Parts List:

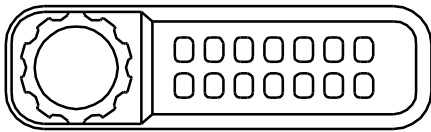

Key Pad

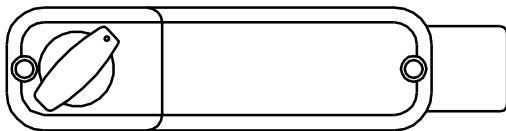

Inside Lock Body

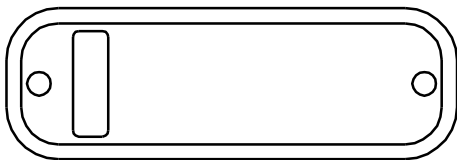

Neoprene Seals x 2

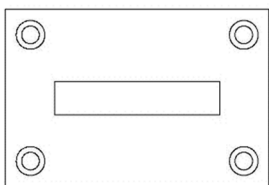

Mortised Lock Keep

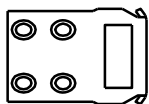

Surface Lock Keep x 2



Wood Screws x 8



Wood Screws x 4



Tweezers x 1

Fixing Bolts (6 supplied)

Use only 2 depending on gate thickness. See table 4A



80 mm x 2 (3 1/8")



70 mm x 1 (2 3/4")



60 mm x 1 (2 3/8")



50 mm x 1 (2")



40 mm x 1 (1 1/2")



Hexagonal shaft x 2
2 3/8" (60mm)



Spare Tumblers
2 x coded
2 x blank



135 mm x 1 (5 5/16")



160 mm x 1 (6 5/16")

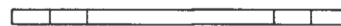

135mm x 1 (5 5/16")

Spindle/ Key Stock x 3

Before commencing installation, check that all parts are working correctly. Press the code into the lock, as per the code card provided and then turn the knob it should turn easily under spring pressure. If you intend to change the code, this should be done before installing the lock, see **"How to Change your Code"**.

How to Change Your Code: The C button must be held down during recoding process

Before installing the lock, or Remove the lock from the door

1. Take **EXTRA** care to keep the keypad on a flat surface when you are removing the cover plate, as there are many small components inside under spring pressure.
2. **Carefully** remove the 2 retaining screws from the back of the keypad that hold the code chamber cover plate in place. The screws are next to the numbers in the plate that has 14 holes in it.
3. You will now see that there are 5 red coloured coded tumblers and 8 blue coloured non-coded tumblers plus 1 clear tumbler ('C' button).
4. **To change your code, push the 'C' button down and hold it.** You can easily remove one or more of your coded and non-coded tumblers using the tweezers supplied.

Remember, the red tumblers represent coded digits and the blue tumblers represent non coded digits.

NOTE: **NEVER** remove the 'C' tumbler.

Please take care to notice the difference in the tumbler shapes before reinserting them into the lock body. Firstly, there is a difference in shape between the coded and non-coded tumblers, illustrated below. Secondly, when fitting the tumblers into the lock body, they must be fitted facing the correct direction, again see illustration below. All square cut outs must face outwards.

5. After you have refitted the tumblers and make note of your new code, please replace the metal plate with the 2 screws.

Table 1A:

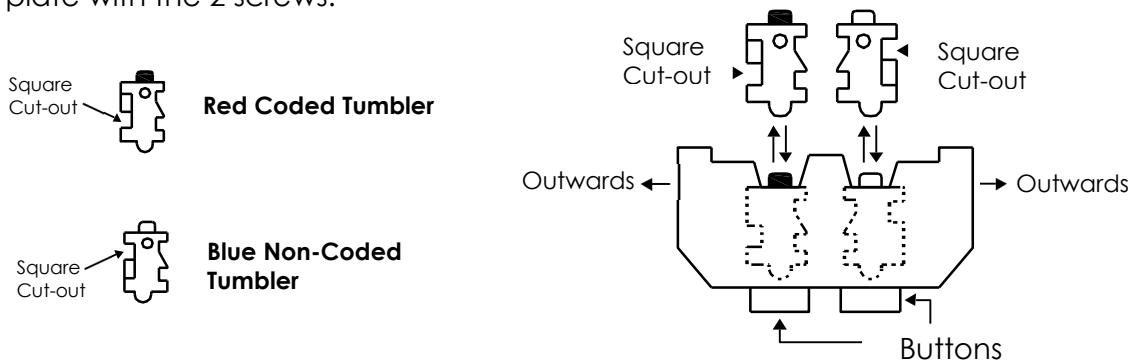

Please note: With the spare tumblers provided, you can either increase the number of digits in your code to 6-7 or reduce your code to 3-4. Numbers may only be part of the code once – you cannot use any number more than once. (i.e 1234 would be acceptable and 1224 would not be acceptable)

How to Check the Hand of Your Door:

Table 2A:

Shown below are all Right Hand Installations (BL2615-RH)

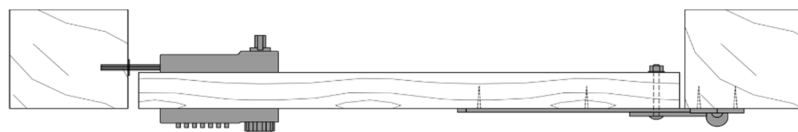

FLUSH ON THE OUTSIDE

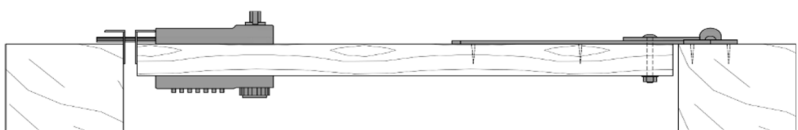

FLUSH ON THE INSIDE

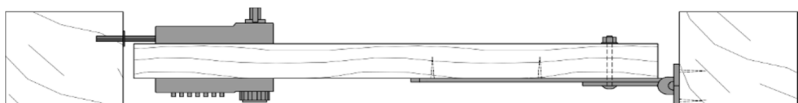

INSTALLED IN CENTER OF OPENING

**Table 3A:
Exploded view**

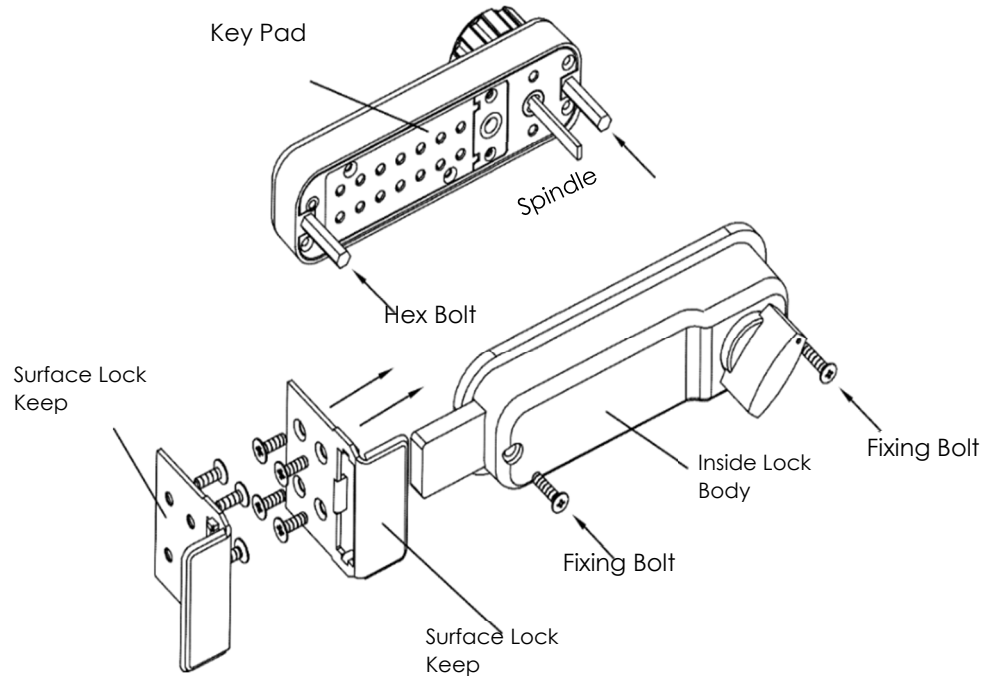

Gate Thickness Table 4A:

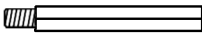
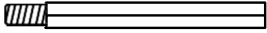
Borg Lock Table			
Hexagonal Shaft Length	Length of Screws Installed	Minimum Gate Thickness	Maximum Gate Thickness
<p>Short</p>  <p>1" (24mm) length supplied on lock</p>	1.5" & 2"	7/8"	1 3/8"
	2" & 2 3/8"	1 1/4"	1 7/8"
	2 3/8" & 2 3/4"	1 3/4"	2 1/4"
	2 3/4" & 3"	2 1/8"	2 3/4"
<p>Long</p>  <p>2 3/8" (60mm) length supplied additionally</p>	1.5" & 2"	2 1/4"	2 3/4"
	2" & 2 3/8"	2 5/8"	3 1/8"
	2 3/8" & 2 3/4"	2 7/8"	3 1/2"
	2 3/4" & 3"	3 1/4"	4 1/8"
	3 1/8"	3 1/2"	4"
<p>Note: Cut Keystock/Spindle 2"-2 1/8" longer than the thickness of your gate or door.</p>			

Maintenance Instructions

Monthly:

Clean the surface of the lock with a silicon based lubricant, remove any excess with a soft cloth. Do NOT use an oil based spray like WD40 as this will attract dirt and debris.

Annually:

Remove the lock from the door.

Spray the inside of the lock thoroughly with a silicon based lubricant, through the tumbler holes at the back of the lock.

Spray all the fixing accessories and the latch with a silicon based lubricant.

Push each of the buttons and rotate the knob several times to ensure that the lock is working smoothly and the lubricant has penetrated the lock appropriately. These procedures can be carried out as needed when lock is sticky or code is accepted intermittently.

Installation instructions:

1. Using table 2A determine which hand (left or right) lock you require for your specific application.
2. Using table 4A determine the length of the machine screws, hexagonal shaft and key stock spindle configuration required for your gate or door thickness. This lock comes standard to fit up to a 4" thick gate or door.
3. Using a hack saw cut the key stock spindle 2 1/8" longer than the thickness of your gate or door. Be careful the key stock spindle is not cut too long as pinching it in between the two parts of the lock body when you install the machine screws during assembly will possibly prevent free movement of the lock parts.
 - a. for gates or doors under the 1 3/4" thickness use the flat key stock spindle and cut to the appropriate length for your application.
 - b. for gates or doors between 1 1/2 " and 3" thick use the key stock spindle that is 135mm and has the heavier "round" part in the middle – the heavier stock will resist twisting better at the longer lengths.
 - c. For gates or doors between 2 3/4" and 4" thick use the key stock spindle that is 160mm and has the heavier "round" part in the middle – the heavier stock will resist twisting better at the longer lengths.

Note: Please take care in cutting the Keystock/Spindles that you cut the correct amount off each end. The Keystock/Spindle seats into the back part of each half of the lock a different depth so you need to account for this when using the Keystock/Spindles that are round in the middle – you will need to cut a little from both ends.

4. Using the supplied drilling template locate where the holes will be drilled in your gate or door by marking the centres. NOTE: The horizontal placement of the lock does not have to match the "edge of door" reference on the drilling template. As the latching bolt moves a full 1 1/2" in its action. If using in the mortised position for instance, it may be advantageous to move the lock position backwards or forwards depending on your specific installation. Please pay special attention to this step to ensure best results.
5. Once you have determined the locks most suitable position, mark the 3 hole centers for drilling, using the appropriate sized bits. The template indicates 8mm (5/16") and 13mm (1/2") holes. Place a block on the opposite side of the door or gate too minimize tear out while drilling.
6. If you haven't already changed the code, but wish to change the code, Please refer to "How to Change Your Code" and do so now.
7. Add the black rubber lock base gaskets to each of the lock pieces at this time.
8. After reviewing the exploded view Table 3A - Carefully affix the lock to the door or gate using the appropriate sized machine screws as determined in step 2. Be sure to install your key stock spindle at this time. **NOTE:** take great care when starting the threads in the hexagonal shaft not to cross thread them. The threads are very fine- it is easy to make a mistake. Tighten gently, do not overtighten.
9. Now the lock position is set you can install surface lock keeps for flush mount applications, or one surface lock keep and one mortise lock keep for mortised installations. Both have elongated receiver slots to allow for some post movement and settling.
10. Test the lock for accurate operation once complete.

If you experience any problems when installing this lock, or changing the code please contact:



SNUG COTTAGE HARDWARE
Marysville Michigan, USA and London, Ontario, Canada
1-800-637-5427
www.snugcottagehardware.com

