

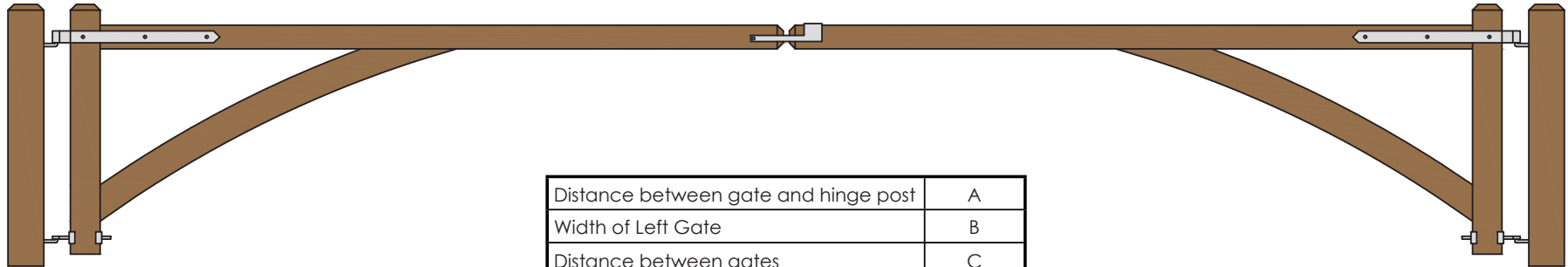

WELDON BARRIER GATE PLAN

Double Gate Configuration - Curved Support Design

Two 10' wide by 44" tall gate - hung between the posts - using Central Eye Hinges (Product Code #8312).



Distance between gate and hinge post	A
Width of Left Gate	B
Distance between gates	C
Width of Right Gate	D
Distance between gate and hinge post	E
Total distance between posts	F

HARDWARE REQUIRED						
Finish Options Available	Galvanized Finish		Black Powder Coat over Galvanized Finish			
Plan Specified Required Hardware						Central Eye Hinge Advantages Opens both ways 100 degrees. Incredible amount of adjustment. Easy operation. Very strong.
Both Sets Include: <i>(All fasteners are included with hardware)</i>	2 of 8312-S242		2 of 8312-S24P			
	two 24 inch double strap (8312-542 or 8312-54SP) two adjustable bottom gate fitting (8250-002 or 8250-00P) four 12" adjustable gate pin (8801-122 or 8801-12P)					
Central Latch Option						Dimensions (feet and inches)
Throw Over Gate Loop(shown)	4200-032		4200-03SP			A B C D E F 4.5" 10' 1" 10' 4.5" 20' - 10"
Optional Gate Holdback						A means of keeping gates open
	4270-122		4270-12SP			
Lumber Required						
Posts	2 of 8' x 6" x 6" (usually dressed out at 5.5" x 5.5")					Rails, Stiles (uprights) and Diagonals made from full 1" thick lumber (commonly sold as decking lumber) or 1" rough cut lumber (4/4).
Rails	6 of 10' x 1" x 5.5"					
Stiles	4 of 8' x 1" x 5.5"					
Diagonals	2 of 8' x 1" x 5.5" (straight support design) or 4 of 8' x 1" x 5.5" (curved support design)					
Filler Blocks	use off cuts from above					
Fasteners Required for Gate Construction						
2 of FP-WeldonBarr. - Fastener Pack for Weldon Barrier Gate Build (Includes 40 of 1.75" wood screws, 2 of 3/8" dowel rod and 9 of 3.5" HDG carriage bolts, nuts and washers)						

Download includes this materials list, component cutting and layout sheet.
 For a complete listing of our Free Gate Plans, please visit snugcottagehardware.com

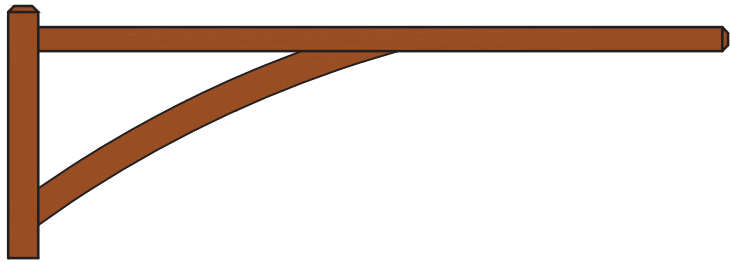

8' CURVED BARRIER GATE

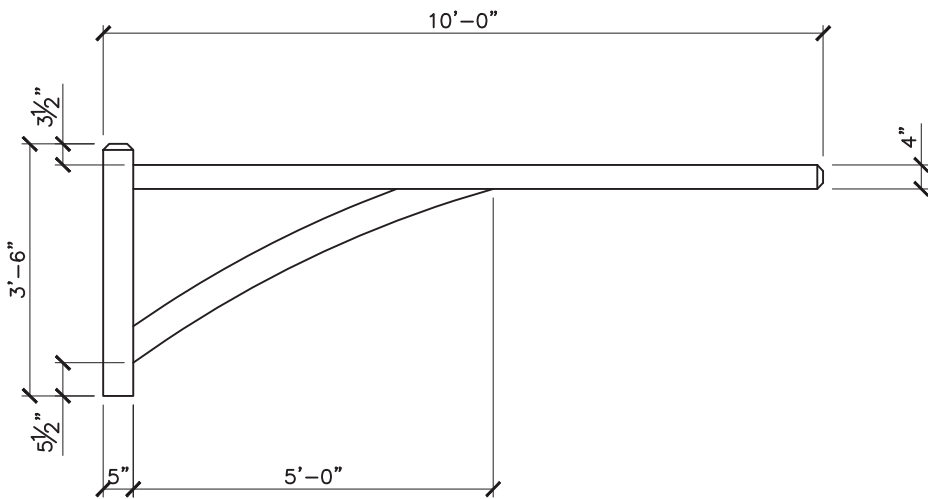

GATE DIMENSIONS

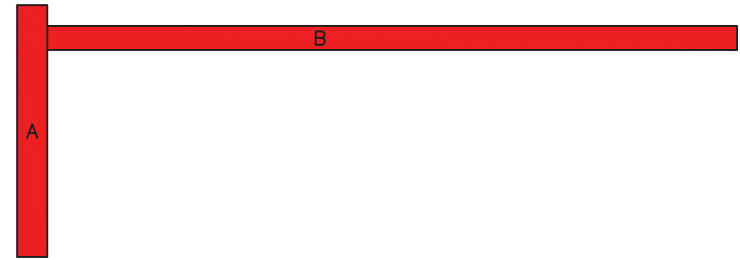

FIRST LAYER

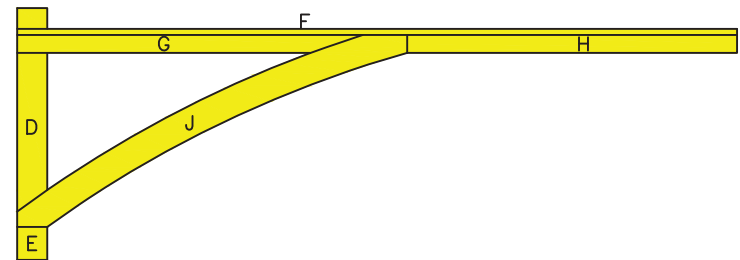

SECOND LAYER

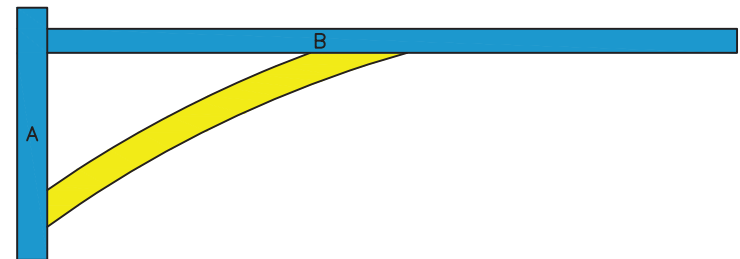

THIRD LAYER

BUILDING STEPS

PROPERTY OF:



PRODUCT DESCRIPTION:

10' WELDON BARRIER GATE
CURVED SUPPORT DESIGN

ALL DIMENSIONS $\pm 0.125"$

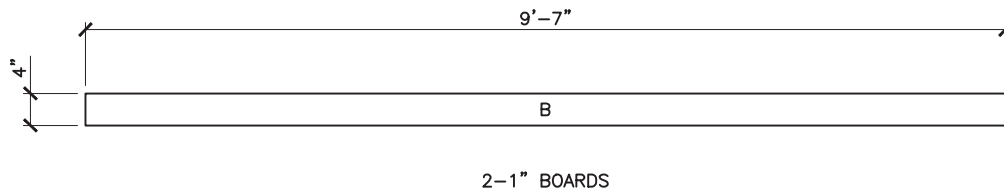
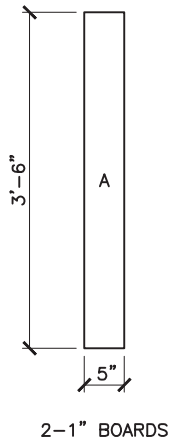

FIRST AND THIRD LAYER COMPONENTS

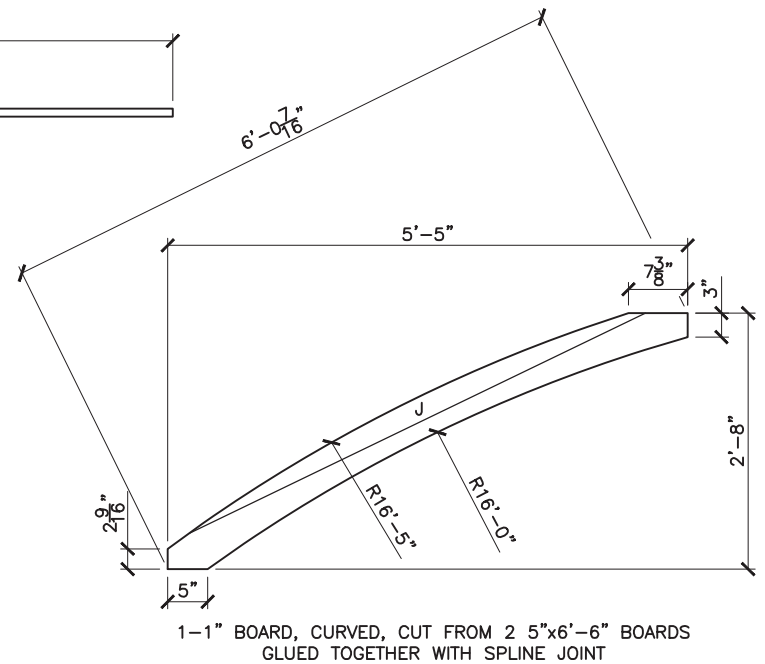
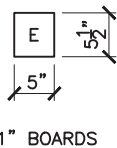
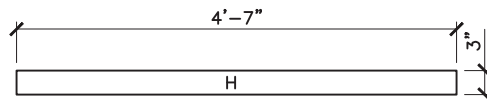
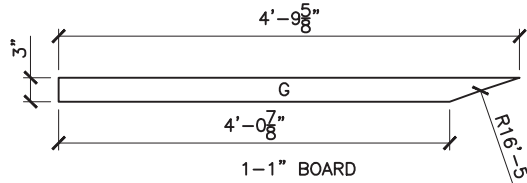
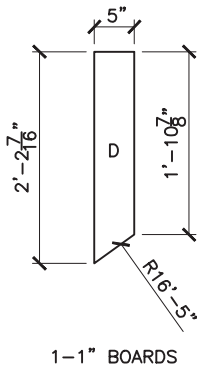
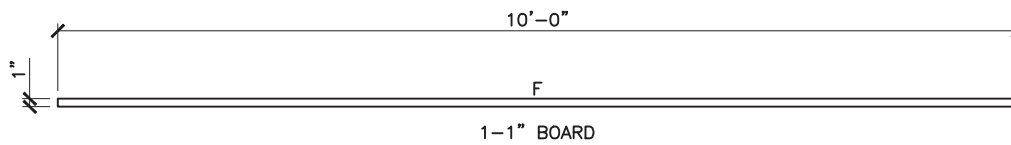
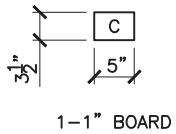

SECOND LAYER COMPONENTS

PROPERTY OF:



PRODUCT DESCRIPTION:

10' WELDON BARRIER GATE CURVED SUPPORT DESIGN COMPONENTS

ALL DIMENSIONS ±0.125"