

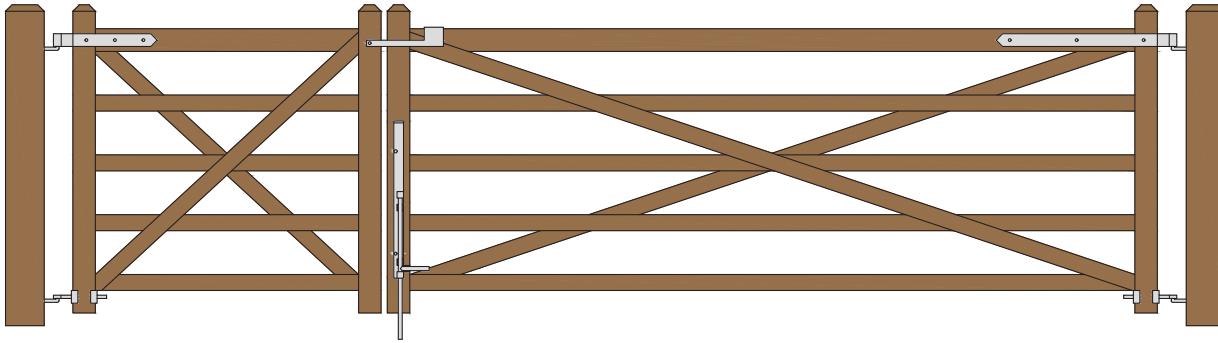

X RAIL GATE PLAN

Double Gate Configuration

4' & 10' wide by 48" tall gates - hung between the posts - using Central Eye Hinges (Product Code #8312).



Distance between gate and hinge post	A
Width of Left Gate	B
Distance between gates	C
Width of Right Gate	D
Distance between gate and hinge post	E
Total distance between posts	F

HARDWARE REQUIRED								
Finish Options Available	Galvanized Finish	Black Powder Coat over Galvanized Finish	Central Eye Hinge Advantages Opens both ways 100 degrees. Incredible amount of adjustment. Easy operation. Very strong.					
Plan Specified Required Hardware								
Both Sets Include: <i>All fasteners are included with hardware</i>	1 of 8312-S122 and 1 of 8312-S242 one 12 inch double strap (8312-422 or 8312-42SP) and one 24 inch double strap (8312-542 or 8312-54SP) two adjustable bottom gate fitting (8250-002 or 8250-00P) four 12" adjustable gate pin (8801-122 or 8801-12P)	1 of 8312-S12P and 1 of 8312-S24P						
Vertical Cane Bolt(s)	1 of 5000-242	1 of 5000-24SP	Dimensions (feet and inches)					
Central Latch Options			A	B	C	D	E	F
Throw Over Gate Loop(shown)	4200-032	4200-03SP	4.5"	4'	1"	10'	4.5"	14' - 10"
Slide Bolt Latch	5002-L122	5002-L12SP	4.5"	4'	1"	10'	4.5"	14' - 10"
Lumber Required								
Posts	2 of 8' x 6" x 6" (usually dressed out at 5.5" x 5.5")		Rails, Stiles (uprights) and Diagonals made from full 1" thick lumber (commonly sold as decking lumber) or 1" rough cut lumber (4/4).					
Rails	3 of 8' x 1" x 5.5" and 5 of 10' x 1" x 5.5"							
Stiles	4 of 8' x 1" x 5.5"							
Diagonals	1 of 8' x 1" x 5.5" and 1 of 12' x 1" x 5.5"							
Filler Blocks	use off cuts from above							
Fasteners Required for Gate Construction								
2 of FP-X Rail - Fastener Pack for "X" Rail Gate Build (Each pack includes 40 of 1.75" wood screws, 16 of 3.5" and 6 of 2.5" HDG carriage bolts, nuts and washers)								

Download includes this materials list, component cutting and layout sheet.
 For a complete listing of our Free Gate Plans, please visit snugcottagehardware.com

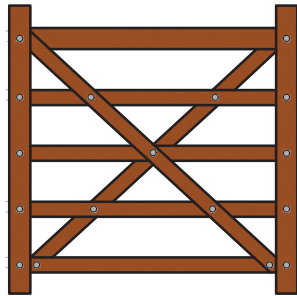

4' 'X' RAIL GATE

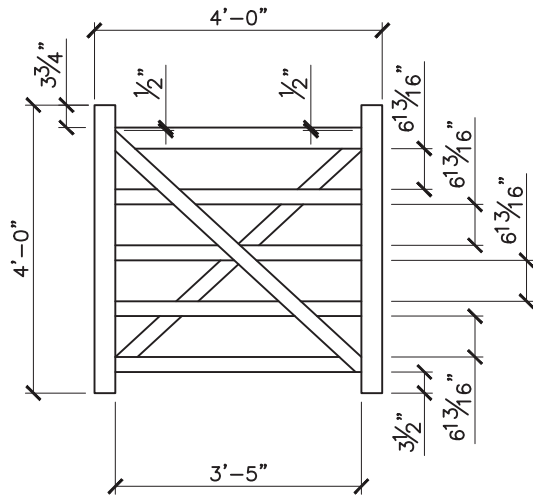

GATE DIMENSIONS

PROPERTY OF:



PRODUCT DESCRIPTION:

4' 'X' RAIL GATE

ALL DIMENSIONS $\pm 0.125"$

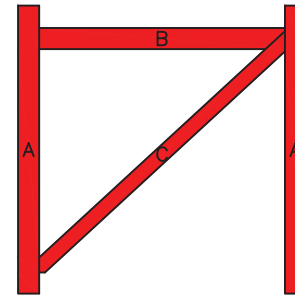

FIRST LAYER

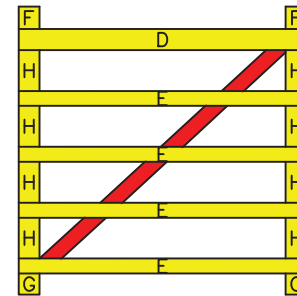

SECOND LAYER

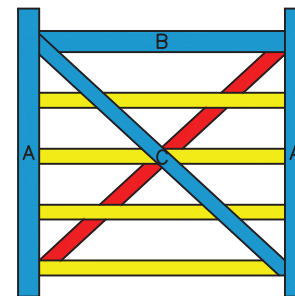

THIRD LAYER

BUILDING STEPS

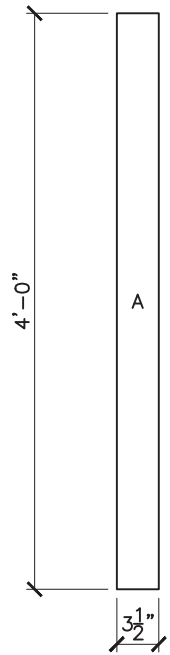

4-1" BOARDS

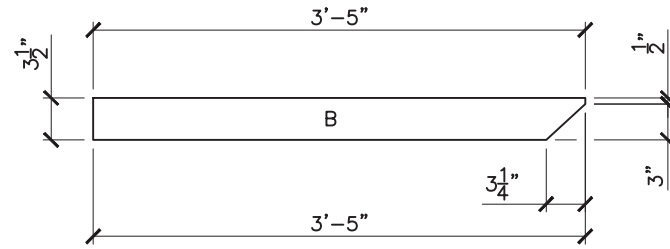

2-1" BOARDS

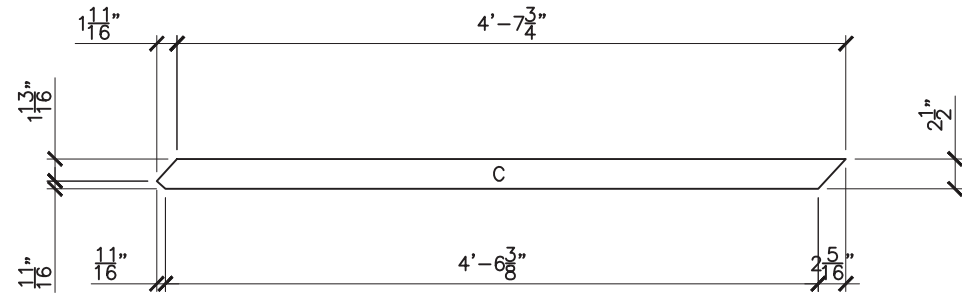

2-1" BOARDS

FIRST AND THIRD LAYER COMPONENTS

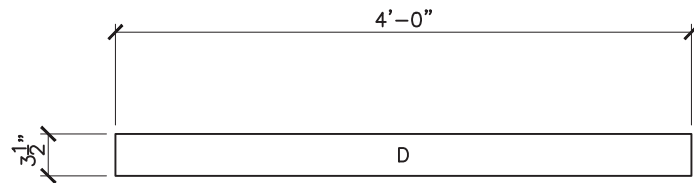

1-1" BOARD

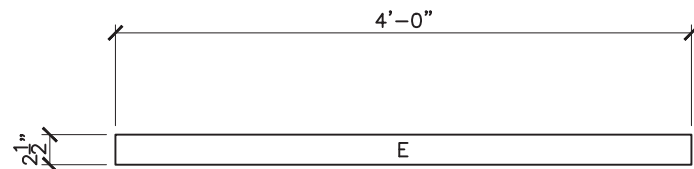

4-1" BOARDS

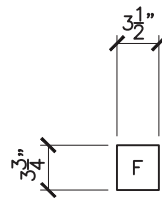

2-1" BOARDS

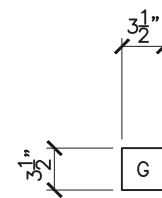

2-1" BOARD

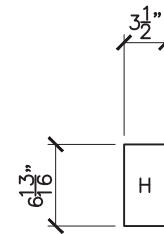

8-1" BOARDS

SECOND LAYER COMPONENTS

PROPERTY OF:



PRODUCT DESCRIPTION:

4' 'X' RAIL GATE COMPONENTS

ALL DIMENSIONS ±0.125"

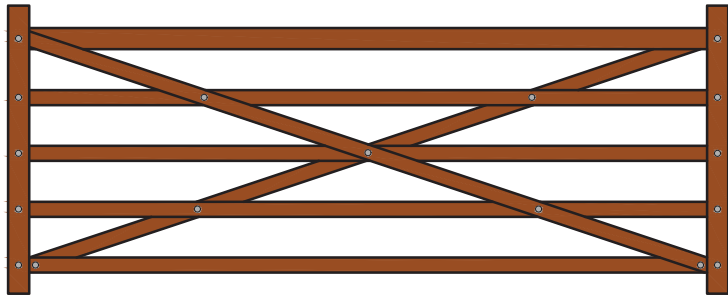

10' 'X' RAIL GATE

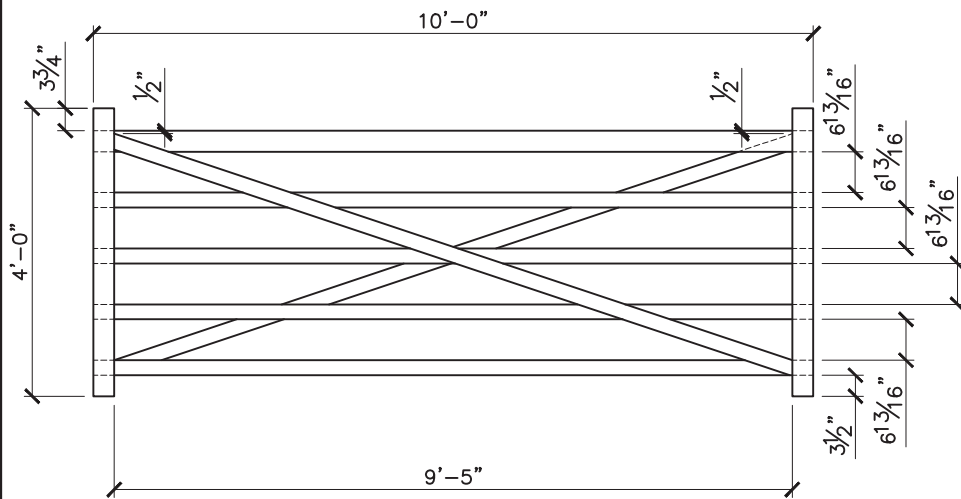

GATE DIMENSIONS

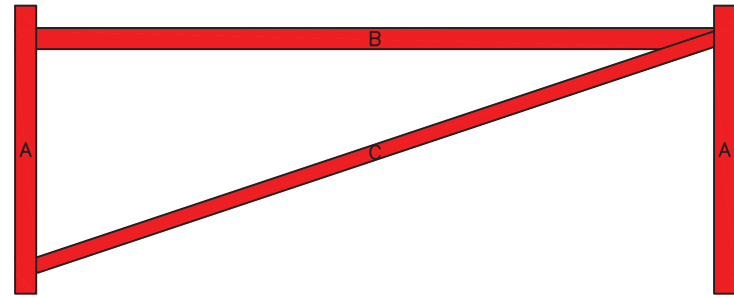

FIRST LAYER

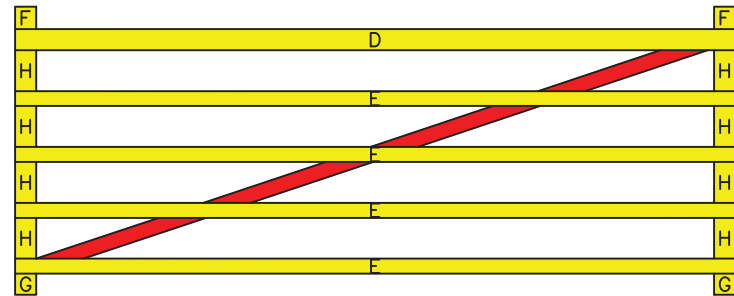

SECOND LAYER

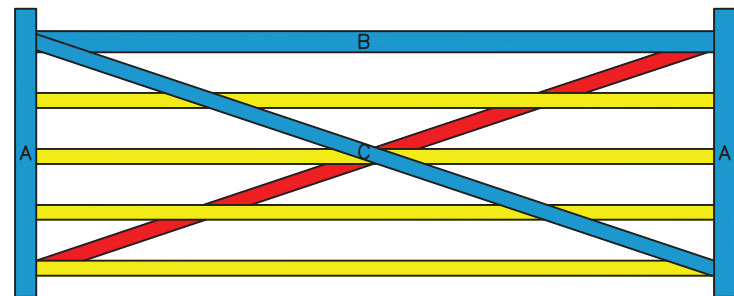

THIRD LAYER

BUILDING STEPS

PROPERTY OF:



PRODUCT DESCRIPTION:

10' 'X' RAIL GATE

ALL DIMENSIONS $\pm 0.125"$

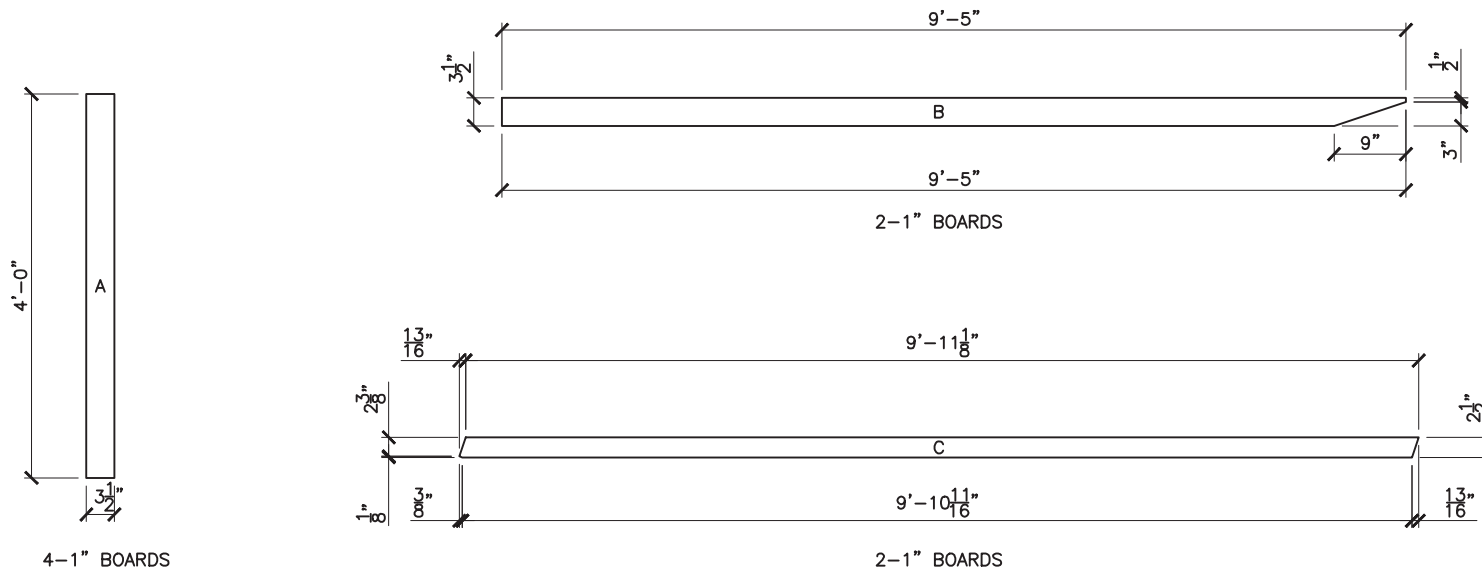

FIRST AND THIRD LAYER COMPONENTS

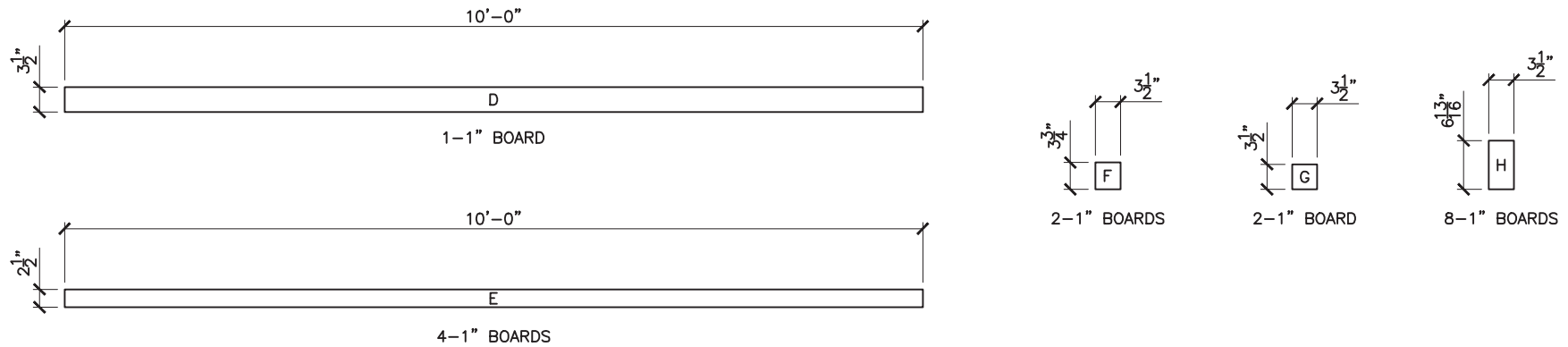

SECOND LAYER COMPONENTS

PROPERTY OF:



PRODUCT DESCRIPTION:

10' 'X' RAIL GATE COMPONENTS

ALL DIMENSIONS ±0.125"

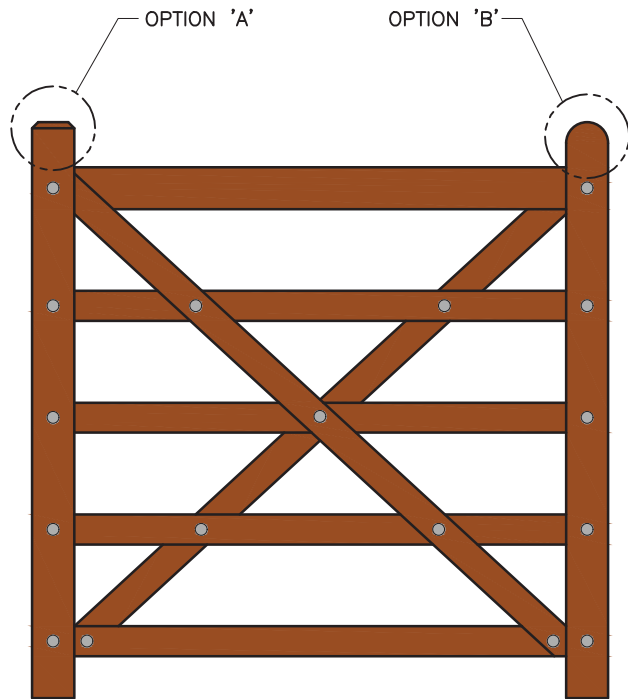

4' 'X' RAIL GATE

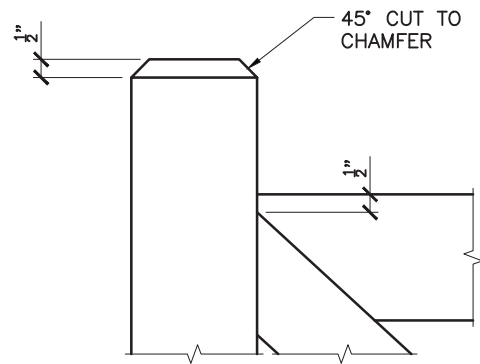

OPTION 'A'

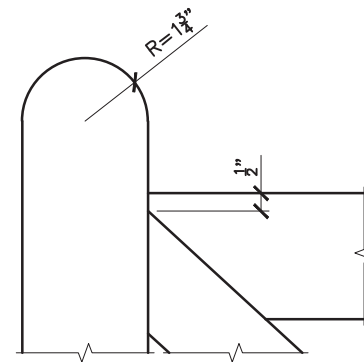

OPTION 'B'

PROPERTY OF:



PRODUCT DESCRIPTION:

TOP RAIL AND STILE DETAIL

ALL DIMENSIONS $\pm 0.125"$